

Aspire 5625 Series Service Guide

Service guide files and updates are available on the ACER/CSD web; for more information, please refer to <http://csd.acer.com.tw>

PRINTED IN TAIWAN

Revision History

Please refer to the table below for the updates made on this service guide.

Date	Chapter	Updates

Copyright

Copyright © 2010 by Acer Incorporated. All rights reserved. No part of this publication may be reproduced, transmitted, transcribed, stored in a retrieval system, or translated into any language or computer language, in any form or by any means, electronic, mechanical, magnetic, optical, chemical, manual or otherwise, without the prior written permission of Acer Incorporated.

Disclaimer

The information in this guide is subject to change without notice.

Acer Incorporated makes no representations or warranties, either expressed or implied, with respect to the contents hereof and specifically disclaims any warranties of merchantability or fitness for any particular purpose. Any Acer Incorporated software described in this manual is sold or licensed "as is". Should the programs prove defective following their purchase, the buyer (and not Acer Incorporated, its distributor, or its dealer) assumes the entire cost of all necessary servicing, repair, and any incidental or consequential damages resulting from any defect in the software.

Acer is a registered trademark of Acer Corporation.

Intel is a registered trademark of Intel Corporation.

Other brand and product names are trademarks and/or registered trademarks of their respective holders.

Conventions

The following conventions are used in this manual:

SCREEN MESSAGES	Denotes actual messages that appear on screen.
NOTE	Gives bits and pieces of additional information related to the current topic.
WARNING	Alerts you to any damage that might result from doing or not doing specific actions.
CAUTION	Gives precautionary measures to avoid possible hardware or software problems.
IMPORTANT	Reminds you to do specific actions relevant to the accomplishment of procedures.



NOTE: This symbol where placed in the Service Guide designates a component that should be recycled according to the local regulations.

Preface

Before using this information and the product it supports, please read the following general information.

1. This Service Guide provides you with all technical information relating to the BASIC CONFIGURATION decided for Acer's "global" product offering. To better fit local market requirements and enhance product competitiveness, your regional office MAY have decided to extend the functionality of a machine (e.g. add-on card, modem, or extra memory capability). These LOCALIZED FEATURES will NOT be covered in this generic service guide. In such cases, please contact your regional offices or the responsible personnel/channel to provide you with further technical details.
2. Please note WHEN ORDERING FRU PARTS, that you should check the most up-to-date information available on your regional web or channel. If, for whatever reason, a part number change is made, it will not be noted in the printed Service Guide. For ACER-AUTHORIZED SERVICE PROVIDERS, your Acer office may have a DIFFERENT part number code to those given in the FRU list of this printed Service Guide. You MUST use the list provided by your regional Acer office to order FRU parts for repair and service of customer machines.

System Specifications	1
Features	1
System Block Diagram	5
Notebook Tour	6
Top View	6
Closed Front View	7
Left View	7
Right View	8
Base View	9
Indicators	9
TouchPad Basics	10
Using the Keyboard	11
Lock Keys and embedded numeric keypad	11
Windows Keys	12
Hot Keys	13
Special Keys	14
Hardware Specifications and Configuration	15
 System Utilities	 33
BIOS Setup Utility	33
Navigating the BIOS Utility	33
Information	34
Main	35
Security	37
Boot	40
Exit	41
BIOS Flash Utility	42
DOS Flash Utility	43
WinFlash Utility	44
Remove HDD/BIOS Password Utilities	45
Removing BIOS Passwords:	46
Miscellaneous Utilities	47
 Machine Disassembly and Replacement	 49
Disassembly Requirements	49
Related Information	49
Replacement Requirements	49
Pre-disassembly Instructions	50
Disassembly Process	51
External Module Disassembly Process	52
External Modules Disassembly Flowchart	53
Removing the Battery Pack	54
Removing the Dummy Card	55
Removing the Base Door	56
Removing the Hard Disk Drive Module	58
Removing the DIMM Module	60
Removing the WLAN Module	61
Removing the ODD Module	63
Removing the RTC Battery	65
Main Unit Disassembly Process	66
Main Unit Disassembly Flowchart	67
Removing the Keyboard	69
Removing the Upper Cover	71
Removing the Switch Board	75

Table of Contents

Removing the Power Board	77
Removing the LCD Module	79
Removing the USB Board	84
Removing the Bluetooth Module	86
Removing the Mainboard	88
Removing the Thermal Module	90
Removing the CPU	91
Removing the PCH Thermal Unit	92
Removing the Power Cable Assembly	93
LCD Module Disassembly Process	95
LCD Module Disassembly Flowchart	95
Removing the LCD Bezel	96
Removing the Camera Board	98
Removing the LCD Panel	99
Removing the Antennas	102
Removing the Microphone Cable	105
LCD Reassembly Procedure	106
Replacing the Microphone	106
Replacing the Antennas	107
Replacing the LCD FPC Cable	110
Replacing the LCD Panel	111
Replacing the Camera Board	113
Replacing the LCD Bezel	114
Main Unit Reassembly Process	117
Replacing the Power Assembly	117
Replacing the PCH Thermal Module	119
Replacing the CPU	119
Replacing the Thermal Module	121
Replacing the Main Board	122
Replacing the USB Card	123
Replacing the Bluetooth Module	125
Replacing the LCD Module	127
Replacing the Power Board	131
Replacing the Switch Board	132
Replacing the Upper Cover	133
Replacing the Keyboard	137
Replacing the Wireless LAN Module	138
Replacing the DIMM Module	140
Replacing the Hard Disk Drive	141
Replacing the RTC Battery	143
Replacing the ODD Module	144
Replacing the Base Door	146
Replacing the Battery	147
Replace the Dummy Card	147

Troubleshooting

149

Common Problems	149
Power On Issue	150
No Display Issue	151
Random Loss of BIOS Settings	152
LCD Failure	153
Built-In Keyboard Failure	154
TouchPad Failure	155
Internal Speaker Failure	156
Internal Microphone Failure	157

Table of Contents

HDD Not Operating Correctly	158
USB Failure	159
Other Failures	159
Intermittent Problems	160
Undetermined Problems	160
POST Code Reference Tables	161
Jumper and Connector Locations	165
Mainboard Top View	165
Mainboard Bottom View	166
BIOS Recovery	167
BIOS Recovery by Crisis Disk	167
FRU (Field Replaceable Unit) List	169
Exploded Diagrams	169
Main Assembly	170
LCD Assembly	172
FRU List	173
Model Definition and Configuration	181
Test Compatible Components	213
Online Support Information	219

Table of Contents

System Specifications

Features

Below is a brief summary of the computer's many features:

Operating System

- Genuine Windows® 7 Home Basic 64-bit
- Genuine Windows® 7 Home Premium 64-bit

Platform

- CPU AMD AthlonII N330 2.3G 1M 35W Dual-Core
- CPU AMD TurionII N530 2.5G 2M 35W Dual-Core
- CPU AMD PhenomII N830 2.1G 35W 1.5M L2, Triple-Core
- CPU AMD PhenomII N930 2.0G 2M 35W Quad-Core
- CPU AMD PhenomII P820 1.8G 25W 1.5M L2, Triple-Core
- CPU AMD PhenomII P920 1.6G 2M 25W Quad-Core
- CPU AMD AthlonII P320 2.1G 1M 25W Dual-Core
- CPU AMD TurionII P520 2.3G 2M 25W Dual-Core

System Memory

- Dual-channel DDR3 SDRAM support:
 - Up to 8GB of DDR3 1066 MHz memory, using two soDIMM modules (for 64-bit OS)

Display

- 15" HD 1366 x 768 pixel resolution, high-brightness (200-nit) Acer CineCrystal™ LED-backlit TFT LCD, supporting simultaneous multi-window viewing via Acer GridVista™
- Mercury free, environment friendly
- 16:9 aspect ratio
- Super-slim design

Graphics

- Park Graphic Chipset or AMD Madison Pro
- Dual independent display support
- 16.7 million colors
- External resolution / refresh rates:
 - VGA port up to 2560 x 1600: 60 Hz
 - HDMI™ port up to 1920 x 1200: 60 Hz
- MPEG-2/DVD decoding WMV9 VC-1 and H.264 (AVC) decoding
- HDMI™ (High-Definition Multimedia Interface) with HDCP (High-bandwidth Digital Content Protection) support

Storage subsystem

- 160/250/320/500/640 GB or larger hard disk drive
- Multi-in-1 card reader, supporting Secure Digital™ (SD), MultiMediaCard (MMC), Memory Stick® (MS), Memory Stick PRO™ (MS PRO), xD-Picture Card™ (xD)

Audio subsystem

- Optimized 3rd Generation Dolby® Home Theater®6 audio enhancement, featuring Dolby® Digital Live, Dolby® Pro Logic® IIx, Dolby® Headphone, Dolby® Natural Bass, Dolby® Sound Space Expander, Dolby® Inverse Filtering, Dolby® High Frequency Enhancer technologies
- High-definition audio support
- S/PDIF (Sony/Philips Digital Interface) support for digital speakers
- MS-Sound compatible
- Built-in microphone

Optical Media Drive

- 8X DVD-Super Multi double-layer drive:
 - Read: 24X CD-ROM, 24X CD-R, 24X CD-RW, 8X DVD-ROM, 8X DVD-R, 8X DVD+R, 6X DVD-ROM DL, 6X DVD-R DL, 6X DVD+R DL, 6X DVD-RW, 6X DVD+RW, 5X DVD-RAM
 - Write: 24X CD-R, 16X CD-RW, 8X DVD-R, 8X DVD+R, 4X DVD-R DL, 4X DVD+R DL, 6X DVD-RW, 8X DVD+RW, 5X DVD-RAM

Communication

- Acer Video Conference, featuring:
 - Acer Crystal Eye high-def webcam with 1280 x 1024 resolution
- WLAN:
 - Acer InViLink™ Nplify™ 802.11 b/g/n Wi-Fi CERTIFIED™
 - Acer InViLink™ 802.11b/g Wi-Fi CERTIFIED™
- WPAN:Bluetooth® 2.1+EDR
- WWAN: UMTS/HSPA at 850/900/1900/2100 MHz and quad-band GSM/GPRS/EDGE(850/900/1800/1900 MHz), upgradeable to 7.2 Mb/s HSDPA and 5.7 Mb/s HSUPA, supporting receiver diversity and equalizing at 2100 MHz
- LAN: Gigabit Ethernet, Wake-on-LAN ready

Privacy control

- BIOS user, supervisor, HDD passwords,
- Kensington lock slot

Dimensions and Weight

- 379 (W) x 250 (D) x 21.7/29.8 (H) mm (14.96 X 9.84 X 0.83/1.18 inches)
- 2.42 kg (5.40 lbs.) with 6-cell battery

Power Adapter and Battery

- ACPI 3.0 CPU power management standard: supports Stand-by and Hibernation power-saving modes

-
- Acer PowerSmart 3-pin 65 W AC adapter
 - 95 (W) x 50 (D) x 25.4 (H) mm (3.74 x 1.96 x 1 inches)
 - 216 g (0.47 lbs)13 with 180 cm DC cable
 - 66.6 W 6000 mAh 6-cell Li-ion standard battery pack
 - Estimated battery life: Up to 8 hours
 - ENERGY STAR®

Special Keys and Controls

- 103-/104-/107-key keyboard, with inverted "T" cursor layout
- 10 function keys, four cursor keys, two Windows® keys, hotkey controls, independent standard numeric keypad, international language support
- Media control keys (printed on keyboard): play/pause, stop, previous, next
- Multi-gesture touchpad, supporting two-finger scroll, pinch, rotate, flip

USB Ports

- Multi-in-1 card reader (SD™, MMC, MS, MS PRO, xD)
- Four USB 2.0 ports
- HDMI™ port with HDCP support
- External display (VGA) port
- Headphone/speaker/line-out jack with S/PDIF support
- Microphone-in jack
- Ethernet (RJ-45) port
- DC-in jack for AC adapter

Software

- Productivity
 - Acer Backup Manager
 - Acer ePower Management
 - Acer eRecovery Management
 - Microsoft® Office Trial (Service Pack 2)
 - Microsoft® Works SE 9
 - Microsoft® Works 9
 - Microsoft® Works 8.5
 - Adobe® Flash® Player 10
 - Adobe® Reader® 9.1
 - eSobi™
 - Google™ Setup
 - Google Toolbar™
 - Norton™ Online Backup
- Security
 - Acer Arcade™ Deluxe
 - Acer InstantOn Arcade

-
- McAfee® Internet Security Suite 2009 Trial
 - McAfee® Virus Definitions
 - MyWinLocker®
 - Multimedia
 - Cyberlink® PowerDVD™
 - NTI Media Maker™
 - Gaming
 - Oberon GameZone Acer Edition
 - WildTangent® Acer Edition
 - Communication and ISP
 - Acer Video Conference Manager
 - Microsoft® Silverlight™
 - Windows Live™ Essentials - Wave 3.2 (Mail, Photo Gallery, Live™ Messenger, Movie Maker, Writer)
 - Utilities and tools
 - Acer Accessory Store
 - Acer Assist
 - Acer Identity Card
 - Acer Registration
 - Acer Updater
 - eBay® shortcut 2009
 - Netflix shortcut

Optional Items

- 1 GB / 2 GB / 4 GB DDR3 1066 MHz soDIMM module
- 6-cell Li-ion battery pack
- 9-cell Li-ion battery pack
- 3-pin 65W AC adapter
- External USB floppy disk drive
- External USB Lite+LSI modem

Warranty

- One-year International Travelers Warranty (ITW)

Environment

- Temperature:
 - Operating: 5°C to 35°C
 - Non-operating: -20°C to 65°C
- Humidity (non-condensing):
 - Operating: 20% to 80%
 - Non-operating: 20% to 80%

NOTE: The specifications listed above are for reference only. The exact configuration of the PC depends on the model purchased.

System Block Diagram

PCB STACK UP
 LAYER 1 : TOP
 LAYER 2 : GND
 LAYER 3 : IN1
 LAYER 4 : IN2
 LAYER 5 : VCC
 LAYER 6 : IN3
 LAYER 7 : GND
 LAYER 8 : BOT

SGM88 ----> Internal CLK GEN.
 QM8 ----> External CLK GEN.
 IV8 ----> IGPU
 SW8 ----> dGPU
 SP8 ----> IGPU & dGPU notice
 SP8B ----> Only for dGPU notice
 SID8B ----> Side port

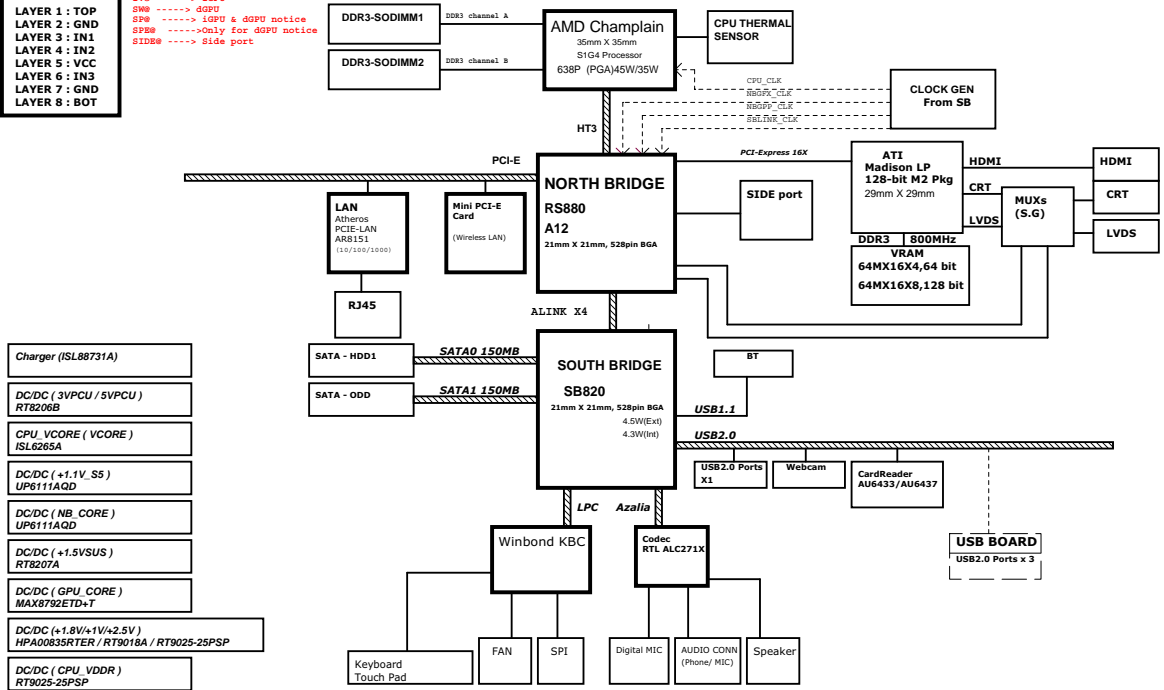







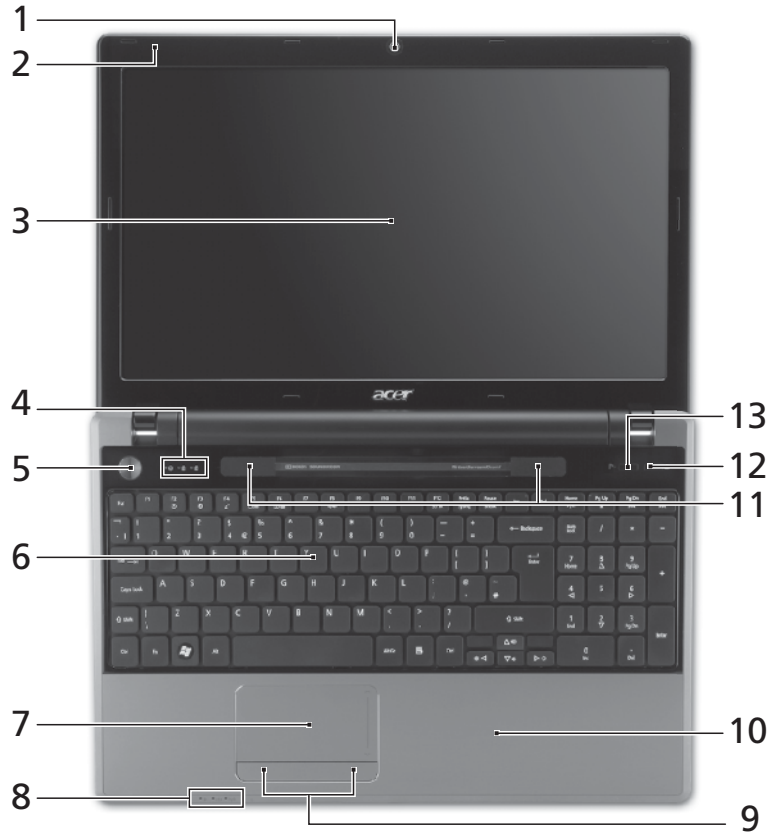



Notebook Tour

This section provides an overview of the features and functions of the notebook.

Top View



#	Icon	Item	Description
1		Acer Crystal Eye webcam	Web camera for video communication. (only for certain models)
2		Microphone	Internal microphone for recording sound.
3		Display screen	Also called Liquid-Crystal Display (LCD), displays computer output (configuration may vary by model).
4		HDD indicator	Indicates when the HDD is active.
		Num Lock indicator	Lights up when the Num Lock is activated.
		Caps Lock indicator	Lights up when the Caps Lock is activated.
5		Power button/	Turns the computer on and off.
6		Keyboard	For entering data into your computer
7		Touchpad	Touch-sensitive pointing device which functions like a computer mouse.

#	Icon	Item	Description
8		Power	Indicates the computer's power status.
		Battery	Indicates the computer's battery status. 1. Charging: The light shows amber when the light is charging. 2. Fully charged: the light shows blue when in AC mode.
		Communication indicator	Indicates the computer's wireless connectivity status.
9		Click buttons (left, and right)	The left and right buttons function like the left and right mouse buttons.
10		Palmrest	Comfortable support area for your hand when using the computer.
11		Speakers	Left and right speakers deliver stereo audio output.
12		Optical drive eject button	Ejects the optical disk from the drive.
13		Programmable key	User-programmable. (only for certain models)
		PowerSmart key	Puts your computer into power-saving mode. (only for certain models)

Closed Front View





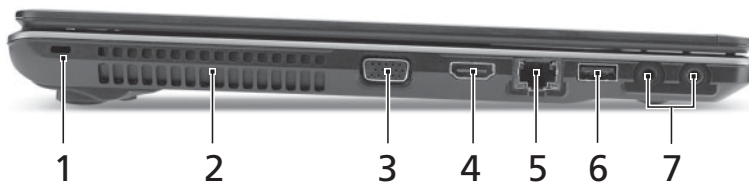

#	Icon	Item	Description
1		Multi-in-1 card reader	Accepts Secure Digital (SD), MultiMediaCard (MMC), Memory Stick (MS), Memory Stick PRO (MS PRO), xD-Picture Card (xD). Note: Push to remove/install the card. Only one card can operate at any given time.

Left View





#	Icon	Item	Description
1		Kensington lock slot	Connects to a Kensington-compatible computer security lock.
2		Ventilation slots	Enable the computer to stay cool, even after prolonged use.

#	Icon	Item	Description
3		External display (VGA) port	Connects to a display device (e.g. external, LCD monitor, LCD projector).
4	HDMI	HDMI port	Supports high definition digital video connections.
5		Ethernet RJ-45) port	Connects to an Ethernet 10/100/1000-based network.
6		USB 2.0 port	Connects to USB 2.0 devices (e.g., USB mouse, USB camera).
7		Microphone jack	Accepts inputs from external microphones.
		Headphones/speaker/line-out jack with S/PDIF support.	Connects to audio line-out devices (e.g., speakers, headphones).

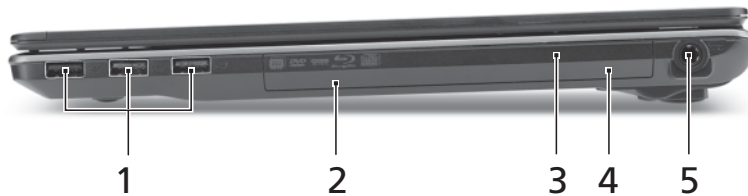



Right View

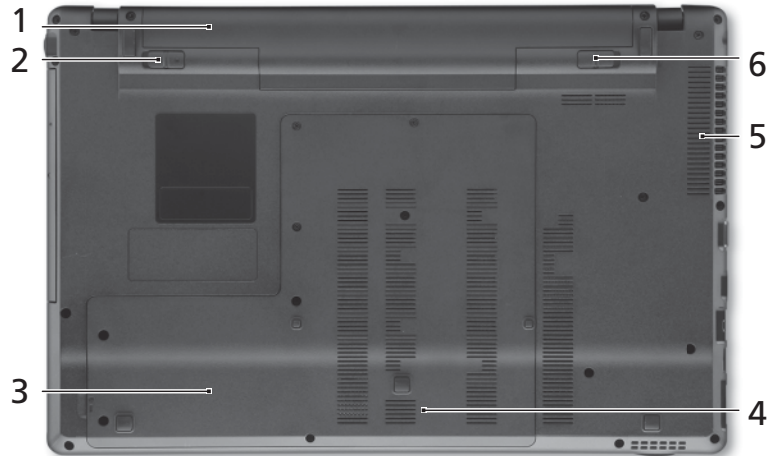

#	Icon	Item	Description
1		USB 2.0 port	Connects to USB 2.0 devices (e.g., USB mouse, USB camera).
2		Optical drive	Internal optical drive; accepts CDs or DVDs.
3		Optical disk access indicator	Lights up when the optical drive is active.
4		Emergency eject hole	Ejects the optical drive tray when the computer is turned off. Note: Insert a paper clip to the emergency eject hole to eject the optical drive tray when the computer is off.
5		DC-in jack	Connects to an AC adapter.







Base View



#	Icon	Item	Description
1		Battery bay	Houses the computer's battery pack. Note: The battery shown is for reference only. Your PC may have a different battery depending on the model purchased.
2		Battery lock	Locks the battery in position
3		Hard disk bay	Houses the computer's hard disk (secured with screws)
4		Memory compartment	Houses the computer's main memory.
5		Ventilation slots and cooling fan	Enable the computer to stay cool, even after prolonged use. Note: Do not cover or obstruct the opening the fan.
6		Battery release latch	Releases the battery for removal.

Indicators

The computer has several easy-to-read status indicators. The battery indicator is visible even when the computer cover is closed.

Icon	Function	Description
	Power	Indicates the computer is on or off.
	Battery	Indicates the computer's battery status.
	Wireless LAN	Indicates the status of Wireless LAN communication.
	HDD	Indicates when the hard disk drive is active.
	Num Lock	Lights up when Num Lock is activated.
	Caps Lock	Lights up when Caps Lock is activated.

NOTE: 1. Charging: The battery light shows amber when the battery is charging. 2. **Fully charged:** The light shows green when in AC mode.

TouchPad Basics

The following items show you how to use the TouchPad:

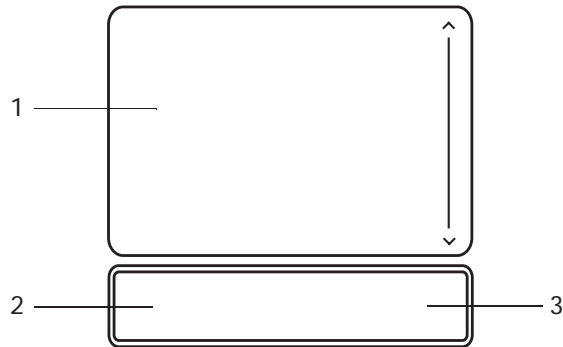

- Move your finger across the TouchPad (1) to move the cursor.
- Press the left (2) and right (3) buttons located beneath the TouchPad to perform selection and execution functions. These two buttons are the equivalent of the left and right buttons on a mouse. Tapping on the TouchPad is the same as clicking the left button.

Function	Left Button (2)	Right Button (3)	Main TouchPad (1)
Execute	Quickly click twice.		Tap twice (at the same speed as double-clicking a mouse button).
Select	Click once.		Tap once.
Drag	Click and hold, then use finger on the TouchPad to drag the cursor.		Tap twice (at the same speed as double-clicking a mouse button); rest your finger on the TouchPad on the second tap and drag the cursor.
Access context menu		Click once.	

NOTE: When using the TouchPad, keep it - and your fingers - dry and clean. The TouchPad is sensitive to finger movement; hence, the lighter the touch, the better the response. Tapping too hard will not increase the TouchPad's responsiveness.

Using the Keyboard

Your computer has a close-to-full-sized keyboard and an embedded numeric keypad, separate cursor, lock, function and special keys.

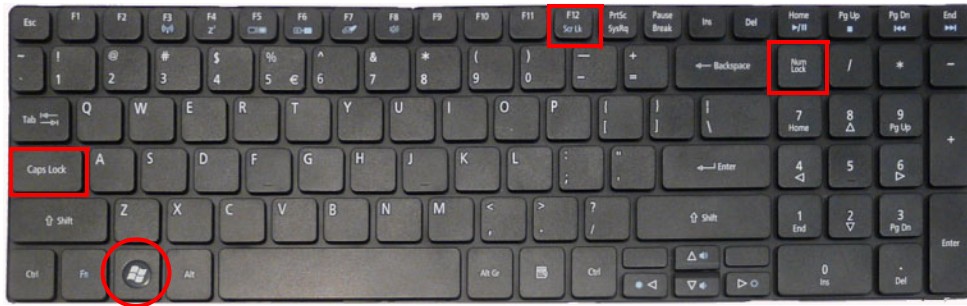

Lock Keys and embedded numeric keypad

The keyboard has three lock keys which you can toggle on and off.













Lock key	Description
Caps Lock	When Caps Lock is on, all alphabetic characters typed are in uppercase.
Num Lock	When Num Lock is on, the embedded keypad is in numeric mode. The keys function as a calculator (complete with the arithmetic operators +, -, *, and /). Use this mode when you need to do a lot of numeric data entry. A better solution would be to connect an external keypad.
Scroll Lock <Fn> + <F12>	When Scroll Lock is on, the screen moves one line up or down when you press the up or down arrow keys respectively. Scroll Lock does not work with some applications.

The embedded numeric keypad functions like a desktop numeric keypad. It is indicated by small characters located on the upper right corner of the keycaps. To simplify the keyboard legend, cursor-control key symbols are not printed on the keys.

Desired access	Num Lock on	Num Lock off
Number keys on embedded keypad	Type numbers in a normal manner.	
Cursor-control keys on embedded keypad	Hold <Shift> while using cursor-control keys.	Hold <Fn> while using cursor-control keys.
Main keyboard keys	Hold <Fn> while typing letters on embedded keypad.	Type the letters in a normal manner.

Windows Keys

The keyboard has two keys that perform Windows-specific functions.

Key	Description
 Windows key	<p>Pressed alone, this key has the same effect as clicking on the Windows Start button; it launches the Start menu. It can also be used with other keys to provide a variety of functions:</p> <ul style="list-style-type: none"><  >: Open or close the Start menu<  > + <D>: Display the desktop<  > + <E>: Open Windows Explore<  > + <F>: Search for a file or folder<  > + <L>: Lock your computer (if you are connected to a network domain), or switch users (if you're not connected to a network domain)<  > + <M>: Minimizes all windows<  > + <R>: Open the Run dialog box<  > + <U>: Open Ease of Access Center<  > + <BREAK>: Display the System Properties dialog box<  > + <TAB>: Cycle through programs on the taskbar<CTRL> + <  > + <F>: Search for computers (if you are on a network) <p>Note: Depending on your edition of Windows 7, some shortcuts may not function as described.</p>
 Application key	This key has the same effect as clicking the right mouse button; it opens the application's context menu.

Hot Keys

The computer employs hotkeys or key combinations to access most of the computer's controls like screen brightness and volume output.

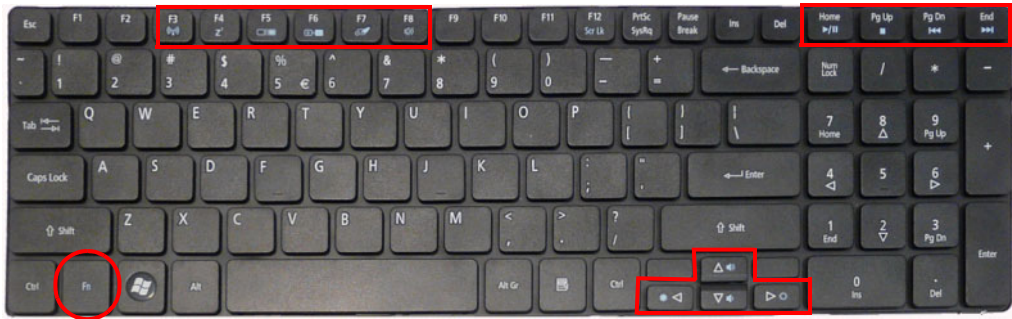

To activate hotkeys, press and hold the <Fn> key before pressing the other key in the hotkey combination.

Hotkey	Icon	Function	Description
<Fn> + <F3>		Wireless communication switch	Enables/disables the Wireless function.
<Fn> + <F4>		Sleep	Puts the computer in Sleep mode.
<Fn> + <F5>		Display toggle	Switches display output between the display screen, external monitor (if connected) and both.
<Fn> + <F6>		Screen blank	Turns the display screen backlight off to save power. Press any key to return.
<Fn> + <F7>		Touchpad toggle	Turns the touchpad on and off.
<Fn> + <F8>		Speaker toggle	Turns the speakers on and off.
<Fn> + <D>		Brightness up	Increases the screen brightness.
<Fn> + <Q>		Brightness down	Decreases the screen brightness.
<Fn> + <Δ>		Volume up	Increases the sound volume.
<Fn> + <∇>		Volume down	Decreases the sound volume.
<Fn> + <Home>		Play/Pause	Plays or pauses media files
<Fn> + <Pg Up>		Stop	Stops media file
<Fn> + <Pg Dn>		Previous	Plays the previous media file in the play sequence
<Fn> + <End>		Next	Plays the next media file in the play sequence

Special Keys

You can locate the Euro symbol and the US dollar sign at the upper-center and/or bottom-right of your keyboard.

The Euro symbol

1. Open a text editor or word processor.
2. Hold <Alt Gr> and then press the <5> key at the upper-center of the keyboard.

NOTE: Some fonts and software do not support the Euro symbol. See www.microsoft.com/typography/faq/faq12.htm for more information.

The US dollar sign

1. Open a text editor or word processor.
2. Hold <Shift> and then press the <4> key at the upper-center of the keyboard.

NOTE: This function varies according to the language settings.

Hardware Specifications and Configuration

SKU Configuration (see below for individual item specifications)

Config/ SKU	C1(UMA)	C2(DIS)	C3(DIS)	C4(DIS)	C5(DIS)
1 ST PN	1ZR8U9R0TN5	1ZR8UAR0TN2	1ZR8UAR0TN3	1ZR8UBR0TN2	1ZR8UCR0TN0
Descriptive	NB,ZR8B(AMD 2.3G/SAM15.6/ SAM1G*2/ HG250)C1	NB,ZR8C(AMD 2.5G/AUO15.6/ HY1G+2G/ WD320)C2	NB,ZR8C(AMD 2.1G/LPL15.6/ EL2G+4G/ TO320)C3	NB,ZR8C(AMD 1.8G/LPL15.6/ EL2G*2/ SE500)C4	NB,ZR8C(AMD 2.0G/AUO15.6/ SA1G+4G/ WD640)C5
AMD CPU	CPU AMD TurionII P520 2.3G 2M 25W Dual-Core	CPU AMD TurionII N530 2.5G 2M 35W Dual-Core	CPU AMD PhenomII N830 2.1G 35W 1.5M L2, Triple-Core	CPU AMD PhenomII P820 1.8G 25W 1.5M L2, Triple-Core	CPU AMD PhenomII N930 2.0G 2M 35W Quad-Core
	AJ0P520UG01	AJ0N530RG00	AJ0N830UG00	AJ0P820UG00	AJ0N930UG00
North Bridge Chip Set	AMD RS880M w/ HDCP EEPROM	AMD RS880M w/ HDCP EEPROM	AMD RS880M w/ HDCP EEPROM	AMD RS880M w/ HDCP EEPROM	AMD RS880M w/ HDCP EEPROM
South Bridge Chip Set	AMD SB820M	AMD SB820M	AMD SB820M	AMD SB820M	AMD SB820M
	AJ069700T01	AJ069700T01	AJ069700T01	AJ069700T01	AJ069700T01
LCD 15.6" Panel	LED LCD SAMSUNG 15.6"W WXGA Glare LTN156AT11-A01 LF 200nit 16ms 500:1 (Power saving)	LED LCD AUO 15.6"W WXGA Glare B156XW04 V0 LF 200nit 8ms 400:1 (Power saving)	LED LCD LPL 15.6"W WXGA Glare LP156WH3-TLL1 LF 200nit 16ms 500:1 (Power saving)	LED LCD LPL 15.6"W WXGA Glare LP156WH3-TLL1 LF 200nit 16ms 500:1 (Power saving)	LED LCD AUO 15.6"W WXGA Glare B156XW04 V0 LF 200nit 8ms 400:1 (Power saving)
	AA156AT0035	AA000156061	AA156WH3006	AA156WH3006	AA000156061
System Memory	Memory SAMSUNG SO-DIMM DDRIII 1066 1GB M471B2873EH 1-CF8 LF 64*16 0.055um	Memory HYNIX SO-DIMM DDRIII 1066 1GB HMT112S6BFR 6C-G7 N0 LF 64*160.055um Memory HYNIX SO-DIMM DDRIII 1066 2GB HMT125S6BFR 8C-G7 N0 LF 128*8 0.055um	Memory ELPIDA SO-DIMM DDRIII 1333 2GB EBJ21UE8BDS 0-DJ-F LF 128*80.065um Memory ELPIDA SO-DIMM DDRIII 1333 4GB EBJ41UF8BAS 0-DJ-F LF 256*8 0.055um	Memory ELPIDA SO-DIMM DDRIII 1066 2GB EBJ21UE8BDS 0-AE-F LF 128*8 0.065um	Memory SAMSUNG SO-DIMM DDRIII 1333 1GB M471B2873FH S-CH9 LF 128*8 46nm Memory SAMSUNG SO-DIMM DDRIII 1333 4GB M471B5273CH 0-CH9 LF 256*8 46nm
	ATR31AAM529	ATR31ABMW5 8 ATR32ABMW2 3	ATR32AAM416 ATR34AAM402	ATR32AAM404	ATR31AAM565 ATR34AAM546

Config/ SKU	C1(UMA)	C2(DIS)	C3(DIS)	C4(DIS)	C5(DIS)
Hard Drive 9.5mm only - SATA	HDD HGST 2.5" 5400rpm 250GB HTS545025B9 A300 Panther B SATA LF F/ W:C60F Disk imbalance criteria = 0.014g-cm	HDD WD 2.5" 5400rpm 320GB WD3200BEVT- 22A23T0,ML32 0S,WD SATA 8MB LF F/ W:01.01A01	HDD TOSHIBA 2.5" 5400rpm 320GB Capricorn BS ,MK3265GSX SATA 8MB LF F/W:GJ001J	HDD SEAGATE 2.5" 5400rpm 500GB ST9500325AS Wyatt SATA LF F/W:0001SDM1	HDD WD 2.5" 5400rpm 640GB WD6400BEVT- 22A0RT0, ML320 SATA 8MB LF F/ W:01.01A01
	AB545025015 0.014g-cm	AB3200BE041 F/W:01.01A01	AB003265002 F/W:GJ002J	AB500325000 F/W:0001SDM1	AB6400BE005 F/W:01.01A01
Super-Multi (5.25"/ 9.5mm-H) SATA	ODD TOSHIBA Super-Multi DRIVE 9.5mm Tray DL 8X TS- U633F LF W/O bezel SATA (HF + Windows 7)	ODD PANASONIC Super-Multi DRIVE 9.5mm Tray DL 8X UJ892 LF W/O bezel SATA GBAS2.0, (HF + Windows7)	ODD HLDS Super-Multi DRIVE 9.5mm Tray DL 8X GU10N LF W/O bezel SATA (HF + Windows 7)	ODD PANASONIC Super-Multi DRIVE 9.5mm Tray DL 8X UJ892 LF W/O bezel SATA GBAS2.0, (HF + Windows7)	ODD TOSHIBA Super-Multi DRIVE 9.5mm Tray DL 8X TS- U633F LF W/O bezel SATA (HF + Windows 7)
	AW000633092 F/W:AC00	AW000892002 F/W:1.00	AW0GU10N004 F/W:AP04	AW000892002 F/W:1.00	AW000633092 F/W:AC00
Battery	Battery PANASONIC AS10B Li-Ion 3S2P PANASONIC 6 cell 6000mAh Main COMMON ID:AS10B56 AS10B5E	Battery SAMSUNG AS10B Li-Ion 3S2P SAMSUNG 6 cell 6000mAh Main COMMON ID:AS10B6E	Battery SIMPLO AS10B Li-Ion 3S2P SAMSUNG 6 cell 6000mAh Main COMMON ID:AS10B7E	Battery PANASONIC AS10B Li-Ion 3S2P PANASONIC 6 cell 6000mAh Main COMMON ID:AS10B56 AS10B5E	Battery SIMPLO AS10B Li-Ion 3S2P SAMSUNG 6 cell 6000mAh Main COMMON ID:AS10B7E
	AHA63230008	AHA63230007	AHA63230005	AHA63230008	AHA63230005
AC Adapter	Adapter LITE- ON 65W 19V 1.7x5.5x11 Yellow PA- 1650-22AC LV5 LED LF	Adapter DELTA 90W 19V 1.7x5.5x11 Blue ADP-90CD DB A, LV5 LED LF	Adapter LITE- ON 90W 19V 1.7x5.5x11 Blue PA-1900-34AR, LV5 LED LF	Adapter LITE- ON 90W 19V 1.7x5.5x11 Blue PA-1900-34AR, LV5 LED LF	Adapter HIPRO 90W 19V 1.7x5.5x11 Blue HP-A0904A3 B1LF, LV5 LED LF
	AG19034B042	AG19047B036	AG19047B037	AG19047B037	AG19047B038
VRAM side port	VRAM HYNIX Graphic DDRIII 800 1Gb H5TQ1G63BFR -12C LF	VRAM HYNIX Graphic DDRIII 800 1Gb H5TQ1G63BFR -12C LF	VRAM SAMSUNG Graphic DDRIII 800 1Gb K4W1G1646E- HC12 LF	VRAM HYNIX Graphic DDRIII 800 1Gb H5TQ1G63BFR -12C LF	VRAM SAMSUNG Graphic DDRIII 800 1Gb K4W1G1646E- HC12 LF
	AKD5LZGTW0 4	AKD5LZGTW0 4	AKD5LGGT506	AKD5LZGTW0 4	AKD5LGGT506

Config/ SKU	C1(UMA)	C2(DIS)	C3(DIS)	C4(DIS)	C5(DIS)
VRAM	#N/A	VRAM HYNIX Graphic DDRIII 800 1Gb H5TQ1G63BFR -12C LF	VRAM SAMSUNG Graphic DDRIII 800 1Gb K4W1G1646E- HC12 LF	VRAM HYNIX Graphic DDRIII 800 1Gb H5TQ1G63BFR -12C LF	VRAM SAMSUNG Graphic DDRIII 800 1Gb K4W1G1646E- HC12 LF
	#N/A	AKD5LZGTW0 4	AKD5LGGT506	AKD5LZGTW0 4	AKD5LGGT506
VGA chip	#N/A	AMD PARK_XT 40nm 29mm*29mm M2 package	AMD PARK_XT 40nm 29mm*29mm M2 package	AMD MADISON_PR O 40nm 29mm*29mm M2 package	AMD MADISON_PR O 40nm 29mm*29mm M2 package
	#N/A	AJ077400T08	AJ077400T08	AJ007720T02	AJ007720T02
Wireless Lan Mini Card	Foxconn Wireless LAN Atheros HB95BG (HM) T77H121.10	Foxconn Wireless LAN Atheros HB93 2x2 BGN (HM)	Foxconn Wireless LAN Broadcomm 43225 2x2 BGN (HM) T77H103.00	Foxconn Wireless LAN Atheros HB97 2x2 BGN (HM)	Foxconn Wireless LAN Atheros HB93 2x2 BGN (HM)
	AD77H121002	AD77H047002 wait for confirm	AD77H103000 wait for confirm	AD77H167001	AD77H047002 wait for confirm
Keyboard	Keyboard ACER AC7T JV40 Internal 14 Standard Black Texture (Darfon)-UI	Keyboard ACER AC7T JV40 Internal 14 Standard Black Texture (Darfon)-UI	Keyboard ACER AC7T JV40 Internal 14 Standard Black Texture (Darfon)-UI	Keyboard ACER AC7T JV40 Internal 14 Standard Black Texture (Chicony)-UI	Keyboard ACER AC7T JV40 Internal 14 Standard Black Texture (Chicony)-UI
	AEZR7R00010	AEZR7R00010	AEZR7R00010	AEZR7R00110	AEZR7R00110
Bluetooth	Foxconn Bluetooth ATH AR3011	Foxconn Bluetooth BRM 2046 BT2.1 (T60H928.33) f/ w:861	Foxconn Bluetooth ATH AR3011	Foxconn Bluetooth BRM 2046 BT2.1 (T60H928.33) f/ w:861	Foxconn Bluetooth ATH AR3011
	ATB77H05600	ATB60H92811	ATB77H05600	ATB60H92811	ATB77H05600
Camera	Suyin 1.3M SY9665SN	Suyin 1.3M SY9665SN	Liteon 1.3M LT9665AL (09P2SF119)	Liteon 1.3M LT9665AL (09P2SF119)	Suyin 1.3M SY9665SN
	AI001315000 current:R02.01. 03	AI001315000 current:R02.01. 03	AI09P2SF013 current:V.0009	AI09P2SF013 current:V.0009	AI001315000 current:R02.01. 03

Processor

Item	Specification
CPU	<ul style="list-style-type: none"> • AMD AthlonII N330 2.3G 1M 35W Dual-Core • AMD TurionII N530 2.5G 2M 35W Dual-Core • AMD PhenomII N830 2.1G 35W 1.5M L2, Triple-Core • AMD PhenomII N930 2.0G 2M 35W Quad-Core • AMD PhenomII P820 1.8G 25W 1.5M L2, Triple-Core • AMD PhenomII P920 1.6G 2M 25W Quad-Core • AMD AthlonII P320 2.1G 1M 25W Dual-Core • AMD TurionII P520 2.3G 2M 25W Dual-Core

CPU Fan True Value Table (UMA)

CPU Temperature (Celsius)	Fan Speed (RPM)	SPL Spec (dBA)
43	2700	28
53	3200	31
62	3500	34
72	3900	37
82	4200	37

Throttling 50%: On= 100°C; OFF=85°C

OS shut down at 105°C; H/W shut down at 110°C

CPU Fan True Value Table (Discrete)

CPU Temperature (Celsius)	Fan Speed (RPM)	SPL Spec (dBA)
38	2700	28
50	3200	31
60	3550	34
67	3900	34
78	4200	37

Throttling 50%: On= 95°C; OFF=90°C

OS shut down at 100°C; H/W shut down at 80°C

North Bridge Chipset

Item	Specification
Chipset	RS880M
Package	<ul style="list-style-type: none"> • Single chip solution in 55nm, 1.1V low power CMOS technology. • 528-FCBGA package, 21mmx21mm.

Item	Specification
Features	<ul style="list-style-type: none"> • CPU HyperTransport. Interface • Supports 16-bit up/down HyperTransport (HT) 3.0 interface up to 4.4 GT/s. • Supports 200, 400, 600, 800, and 1000 MHz HT1 frequencies. • Supports 1.6, 1.8, 2.0, and 2.2 GHz HT3 frequencies. • Supports AMD AM3 and S1g3-socket CPUs, including the AMD Phenom II and Caspian-series processors. • Supports LDTSTOP interface and CPU link stutter mode. <p>ATI HyperMemory.</p> <ul style="list-style-type: none"> • Supports ATI HyperMemory.*. <p>* Note: Includes dedicated and shared memory. The amount of HyperMemory available is determined by various factors. For details, please consult your AMD CSS representative.</p> <p>PCI ExpressR Interface</p> <ul style="list-style-type: none"> • Supports PCIe Gen2 (version 2.0). • Optimized peer-to-peer and general purpose link performance. • Highly flexible PCI Express implementation to suit a variety of platform needs. • A dual-port, x16 graphics interface. • Supports programmable lane reversal for the graphics link to ease motherboard layout when the end device does not support lane reversal (not applicable to the RS880MC). • Supports six general purpose lanes, for up to six devices on specific ports. <p>A-Link Express II Interface</p> <ul style="list-style-type: none"> • One x4 A-Link Express II interface for connection to an AMD Southbridge. The A-Link Express II is a proprietary interface developed by AMD basing on the PCI Express Gen2 version 2.0 technology, with additional Northbridge-Southbridge messaging functionalities. • Supports programmable lane reversal to ease motherboard layout. <p>2D Acceleration Features</p> <ul style="list-style-type: none"> • Highly-optimized 128-bit engine, capable of processing multiple pixels per clock. • Hardware acceleration of Bitblt, line drawing, polygon and rectangle fills, bit masking, monochrome expansion, panning and scrolling, scissoring, and full ROP support (including ROP3). • Optimized handling of fonts and text using AMD proprietary techniques. • Game acceleration including support for Microsoft's DirectDrawR: Double Buffering, Virtual Sprites, Transparent Blit, and Masked Blit. • Acceleration in 1/8/15/16/32-bpp modes: <ul style="list-style-type: none"> • Pseudocolor mode for 8bpp • ARGB1555 and RGB565 modes for 16bpp • ARGB8888 mode for 32bpp • Significant increase in the High-End Graphics WinBenchR score due to capability for C18 color expansion. • Setup of 2D polygons and lines.

Item (NB Cont.)	Features
	<ul style="list-style-type: none"> • Support for GDI extensions: • In Windows XP and Windows Vista: Alpha BLT, Transparent BLT, and Gradient Fill. • In Windows 7: Alpha BLT, Transparent BLT, Color Fill BLT, Stretch BLT, and Clear Type BLT. • Hardware cursor (up to 64x64x32bpp), with alpha channel for direct support of Windows XP, Windows Vista and irons 7 alpha cursor. • 3D Acceleration Features • Fully DirectX 10.1 compliant, including full speed 32-bit floating point per component operations • Shader Model 4.1 geometry and pixel support in a unified shader architecture: • Full speed 32-bit floating point processing per component. • High dynamic range rendering with floating point blending, texture filtering and anti-aliasing support. • High performance dynamic range computations • Full anti-aliasing on render surfaces up to and including 128-bit floating point formats. • Support for OpenGL 2.0 • Anti-Aliasing Filtering: • 2x/4x/8x modes. • Sparse multi-sample algorithm with gamma correction, programmable sample patterns, and centroid sampling. • Temporal anti-aliasing. • Adaptive anti-aliasing mode. • Lossless color compression (up to 8:1) at all resolutions, up to and including widescreen HDTV. • Anisotropic Filtering: • 2x/4x/8x/16x modes • Up to 128-tap texture filtering. • Adaptive algorithm with performance (bi-linear) and quality (tri-linear) options. • Improved quality mode due to improved subpixel precision, higher precision LOD computations, and rotationally invariant LOD computations. • Advanced Texture Compression (3Dc+ .): • High quality 4:1 compression for normal maps and luminance maps. • Works with any single-channel or two-channel data format. • HW support to overcome "Small batch" issues in CPU limited applications. • 3D resources virtualized to a 32-bit addressing space, for support of large numbers of render targets and textures. • New vertex cache and vertex fetch design, to increase vertex throughput from previous generations. • Full support of 64-bit and 128-bit textures and surfaces, which can be 4x to 8x faster than previous generation of HW. • Up to 8K x 8K textures, including 128 bpp texture are supported.

Item (NB Cont.)	Features
	<ul style="list-style-type: none"> • New multi-level texture cache to give optimal performance, greater than 8x the previous designs. • High efficiency ring bus memory controller: • Programmable arbitration logic maximizes memory efficiency, software upgradeable. • Fully associative texture, color, and Z cache design. • New hierarchical Z and stencil buffers with early Z Test. • New lossless Z-buffer compression for both Z and stencil. • Fast Z-Buffer Clear. • Z cache optimized for real-time shadow rendering. • Z and color compression resources virtualized to a 32-bit addressing space, for support of multiple render targets and textures simultaneously. <p>Motion Video Acceleration Features</p> <ul style="list-style-type: none"> • Video scaling and fully programmable YCrCb to RGB color space conversion for full-speed video playback and fully adjustable color controls. • Adaptive de-interlacing eliminates video artifacts caused by displaying interlaced video on non-interlaced displays, and by analyzing image and using optimal de-interlacing function on a per-pixel basis. • H.264 implementation is based on the ISO/IEC 14496-10 spec. • VC-1 implementation is based on the SMPTE 421M spec. • For the RS880MC: MPEG-2 decode acceleration for SD contents: • Hardware motion compensation. • Hardware Inverse Discrete Cosine Transform. • Multiple Display Features <p>General</p> <ul style="list-style-type: none"> • Resolution, refresh rates, and display data can be completely independent for the two display paths. • jE Each display controller supports true 30 bits per pixel throughout the display pipe. • jE Each display path supports VGA and accelerated modes, video overlay, hardware cursor, hardware icon, and palette gamma correction. • Supports both interlaced and non-interlaced displays. • Full ratiometric expansion ability is supported for source desktop modes up to 1920 pixels/line. • Maximum DAC frequency of 400 MHz. • Supports 8, 16, 32, and 64-bpp depths for the main graphics layer: • For 32-bpp depth, supports xRGB 8:8:8:8, xRGB 2:10:10:10, sCrYCb 8:8:8:8, and xCrYCb 2:10:10:10 data formats. • For 64-bpp depth, supports xRGB 16:16:16:16 data format. • Independent gamma, color conversion and correction controls for main graphics layer. • Support for DDC1 and DDC2B+ for plug and play monitors. • 8-bit alpha blending of graphics and video overlay.

Item (NB Cont.)	Features
	<ul style="list-style-type: none"> • Hardware cursor up to 64x64 pixels in 2 bpp, full color AND/XOR mix, and full color 8-bit alpha blend. • Hardware icon up to 128x128 pixels in 2 bpp, with two colors, transparent, and inverse transparent. AND/XOR mixing. Supports 2x2 icon magnification. • Virtual desktop support. • Support for flat panel displays via VGA. <p>VGA Output</p> <ul style="list-style-type: none"> • Maximum resolutions supported by the VGA output for different refresh rates are: <ul style="list-style-type: none"> • 2048x1536 @85Hz (pixel clock at 388.5MHz) for 4:3 format • 2560x1440 @75Hz (pixel clock at 397.25MHz) for 16:9 format • 2456x1536 @60Hz (pixel clock at 320MHz) for 16:10 format <p>1.3.10 Integrated LVDS Interface</p> <ul style="list-style-type: none"> • Integrated dual-link 24-bit LVDS interface. • 805 Mbps/channel with 115 MHz pixel clock rate per link (230 MHz maximum pixel clock). • FPDI-2 compliant; compatible with receivers from National Semiconductor, Texas Instruments, and THine. • OpenLDI compliant excluding DC balancing. • Programmable internal spread spectrum controller for the signals. <p>System Clocks</p> <ul style="list-style-type: none"> • Support for an external clock chip to generate side-port memory, PCIe, and A-Link Express II clocks. Alternatively, internal generation for these clocks, with clock input from an SB800-series Southbridge, can be used (subject to characterization with actual RS880M and SB800-series devices). <p>Power Management Features</p> <ul style="list-style-type: none"> • Single chip solution in 55nm, 1.1V CMOS technology. • Supports ACPI 2.0 for S0, S3, S4, and S5 states. • Full IAPC (Instantly Available PC) power management support. • Static and dynamic power management support (APM as well as ACPI) with full VESA DPM and Energy Star compliance. • The Chip Power Management Support logic supports four device power states defined for the OnNow Architecture - On, Standby, Suspend, and Off. Each power state can be achieved by software control bits. • Hardware controlled intelligent clock gating enables clocks only to active functional blocks, and is completely transparent to software. • Support for Cool'n'Quiet. via FID/VID change. • Support for AMD PowerNow! • Clocks to every major functional block are controlled by a unique dynamic clock switching technique that is completely transparent to the software. By turning off the clock to the block that is idle or not used at that point, the power consumption can be significantly reduced during normal operation. • Supports AMD Vari-Bright., ATI PowerXpress., and ATI PowerPlay. (enhanced with the ATI PowerShift. feature). • Supports dynamic lane reduction for the PCIe graphics interface when coupled with an AMD-based graphics device, PC Design Guide Compliance

Item (NB Cont.)	Features
	<ul style="list-style-type: none"> • The RS880M complies with all relevant Windows Logo Program (WLP) requirements from Microsoft for WHQL certification. <p>Test Capability Features</p> <p>The RS880M has a variety of test modes and capabilities that provide a very high fault coverage and low DPM (Defect Per Million) ratio:</p> <ul style="list-style-type: none"> • Full scan implementation on the digital core logic through ATPG (Automatic Test Pattern Generation Vectors). • Dedicated test logic for the on-chip custom memory macros to provide complete coverage on these modules. • A JTAG test mode to allow board level testing of neighboring devices. • An EXOR tree test mode on all the digital USB's to allow for proper soldering verification at the board level. • A VOH/VOL test mode on all digital USB's to allow for proper verification of output high and output low values at the board level. • Access to the analog modules to allow full evaluation and characterization. • IDDQ mode support to allow chip evaluation through current leakage measurements. • These test modes can be accessed through the settings on the instruction register of the JTAG circuitry. <p>Additional Features</p> <ul style="list-style-type: none"> • Integrated spread spectrum PLLs on the memory and LVDS interface.

Southbridge Chipset

Item	Feature
Chipset	SB820M
Package	
Features	<p>*Processor Interface Supports AMD mobile processors code-named “Champlain,” and “Geneva.”</p> <p>*A-Link Express II interface to Northbridges 1-, 2-, or 4-lane A-Link Express II *interface Automatic detection of lane configuration on boot-up Dynamic lane width up/down configuration on detecting bandwidth requirement Supports transfer rate of up to 2.5 GT/s per lane.</p> <p>*PCI ExpressR Controller Two-lane PCI ExpressR (PCIeR) 1.x interface, supporting up to two general purpose devices. Supported configurations include: 1x2 2x1</p> <p>*PCI Host Bus Controller Supports PCI bus at 33MHz Supports PCI Rev. 2.3 specification Supports up to 4 bus master devices Supports 40-bit addressing Interrupt steering supported for plugn-play devices Supports concurrent PCI operations BIOS/hardware support to hide PCI device Supports spread spectrum</p> <p>*USB Controllers 4 OHCI and 3 EHCI host controllers to support 14 USB 2.0 ports and 2 dedicated USB 1.1 ports Supports ACPI S1 ~ S5 Supports legacy keyboard/mouse USB debug port *Supports port disable with individual control</p> <p>*SMBus Controller Supports SMBALERT # signal</p> <p>*Interrupt Controller Supports IOAPIC/X-IO APIC mode for 24 channels of interrupts Supports 8259 legacy mode for 15 interrupts Supports programmable level/edge triggering on each channels Supports serial interrupt on quiet and continuous modes</p> <p>*DMA Controller Two cascaded 8237 DMA controllers Supports LPC DMA Supports type F DMA</p> <p>*LPC host bus Controller Supports LPC-based super USB and flash devices Supports two master/DMA devices Supports TPM version 1.1/1.2 devices for enhanced security Supports SPI devices and SPI ROM sharing Supports a maximum SPI ROM size of 16MB</p>

Item (SB Cont.)	Feature
	<p>*SATA Controller</p> <p>Supports six Third generation SATA ports (compatible with devices running at 6 Gbits/s, 3 Gbit/s, and 1.5 Gbit/s)</p> <p>Complies with SATA 2.6 specification</p> <p>Supports three modes of operation:</p> <p>*IDE emulation mode</p> <p>AHCI mode (compliant with AHCI specification revision 1.2)</p> <p>RAID mode</p> <p>*Any of the six ports can be configured to a lower transfer rate of 3 or 1.5 Gbit/s for saving power.</p> <p>Any of the six SATA ports can be configured to support Second generation e-SATA port (compatible with devices running at 3 Gbit/s and 1.5 Gbit/s; Third generation e-SATA not supported as per the SATA 3.0 Specification).</p> <p>Supports DIPM, HIPM, hot plug, and NCQ in AHCI mode.</p> <p>*AMD RAID Support</p> <p>Supports integrated RAID 0 and RAID 1 functionality across all 6 ports</p> <p>*AHCI Support</p> <p>Supports AHCI hardware assist (version 1.2) to support advanced features such as NCQ (Native Command Queuing), hotplug, and *Device or Host Initiated Power Management (DIPM /HIPM)</p> <p>*High Definition Audio</p> <p>Four independent output streams (DMA)</p> <p>Four independent input streams (DMA)</p> <p>Multiple channels of audio output per stream</p> <p>*Supports up to 4 codecs</p> <p>Up to 192kHz sample rate and 32-bit audio</p> <p>64-bit addressing capability for DMA bus master and MSI</p> <p>Unified Audio Architecture (UAA) compatible</p> <p>HD Audio registers can be located anywhere in the 64-bit address space</p> <p>Supports 3.3V/1.5V dual-voltage interface for power saving</p> <p>*Gigabit Ethernet Media Access</p> <p>*Controller (GbE MAC)</p> <p>Supports RGMII/MII interface to Ethernet PHY (for selected Broadcom Rtransceivers only)</p> <p>10/100/1000Base-T full duplex or half duplex MAC</p> <p>Supports Receive Side Scaling (RSS)</p> <p>IPv4 and IPv6 Large Send Offload (LSO)</p> <p>IPv4 and IPv6 Checksum Offload</p> <p>Wake-on-LAN (WoL) support</p> <p>*Timers</p> <p>8254-compatible timer</p> <p>Microsoft High Precision Event Timer (HPET)</p> <p>ACPI power management timer</p> <p>Watchdog timer</p> <p>*Real Time Clock (RTC)</p> <p>256-byte battery-backed CMOS RAM</p> <p>Hardware supported century rollover</p> <p>Hardware supported day-light saving feature</p> <p>RTC battery monitoring feature</p>

Item (SB Cont.)	Features
	<p>*Power Management</p> <p>ACPI specification 3.0 compliant power management schemes</p> <p>Supports CPU C1e, C2, C3, C3 pop-up, C4, and C5 states</p> <p>Supports system S0, S1, S3, S4, and S5 states</p> <p>Wakeup events for S1, S3, S4, and S5 generated by:</p> <p>Any GEVENT pin</p> <p>Any GPM pin</p> <p>USB</p> <p>Power Button</p> <p>Internal RTC wakeup</p> <p>SMI event</p> <p>Consumer IR</p> <p>CPU SMM support, generating SMI message upon power management events</p> <p>CLKRUN# support for PCI power management Provides clock generator and CPU</p> <p>vSTPCLK# control Supports hardware monitoring and fan control</p> <p>ALPM (HIPM) on SATA</p> <p>DIPM on SATA</p> <p>*Consumer IR</p> <p>Media center infrared with wake from all states</p> <p>Two transmitters</p> <p>IR receiver and wideband learning receiver</p> <p>*Hardware Monitoring</p> <p>Temperature monitoring</p> <p>Monitor temperature range from 0 to 95°C, with an accuracy of +/-5°C</p> <p>Voltage monitoring</p> <p>Fan control</p> <p>Supports up to 5 fans</p> <p>Access to ACPI Features through</p> <p>SMBus</p> <p>ASFBus</p> <p>GPIO</p> <p>*Integrated Clock Function</p> <p>Provides 25MHz, 14.318MHz, and 48MHz clocks</p> <p>Provides CPU_HT and NB_HT clocks</p> <p>Provides graphics, A-Link Express II, and nine general PCIe Rclocks</p>

System Memory

Item	Specification
Memory size	0MB (No on-board Memory)
DIMM socket number	204-pin sockets
Supports memory size per socket	4GB
Supports maximum memory size	8GB
Supports DIMM type	DDR3 SoDIMM
Supports DIMM Speed	400 MHz fCK for 800Mb/sec/pin, 533MHz fCK for 1066Mb/sec/pin.

Video Specifications

Item	Specification	
Chipset*	AMD PARK_XT	AMD MADISON_PRO
Package	40nm 29mm*29mm M2	40nm 29mm*29mm M2

* For discrete models only

LCD Display/HDMI Resolutions Supported

Resolution	24 bits	30 bits	36 bits	48 bits
640x480p/60Hz 4:3	Yes	Yes	Yes	Yes
720x480p/60Hz 4:3	Yes	Yes	Yes	Yes
720x480p/60Hz 16:9	Yes	Yes	Yes	Yes
1280x720p/60Hz 16:9	Yes	Yes	Yes	Yes
1920x1080i/60Hz 16:9	Yes	Yes	Yes	Yes
1440x480i/60Hz 4:3	Yes	Yes	Yes	Yes
1440x480i/60Hz 16:9	Yes	Yes	Yes	Yes
1920x1080p/60Hz 16:9	Yes	Yes	Yes	Yes
720x576p/50Hz 4:3	Yes	Yes	Yes	Yes
720x576p/50Hz 16:9	Yes	Yes	Yes	Yes
1280x720p/50Hz 16:9	Yes	Yes	Yes	Yes
1920x1080i/50Hz 16:9	Yes	Yes	Yes	Yes
1440x576i/50Hz 4:3	Yes	Yes	Yes	Yes
1440x576i/50Hz 16:9	Yes	Yes	Yes	Yes
1920x1080p/50Hz 16:9	Yes	Yes	Yes	Yes

Hard Disk Drive Interface

Item	Specification			
Vendor & Model Name	Seagate	HGST	Toshiba	Western Digital
Capacity (GB)	160, 250, 320, 500	160, 250, 320, 500	160, 250, 320, 500	160, 250, 320, 500, 640
Bytes per sector	512			
Data heads	2-4			
Drive Format				
Disks	1-2			

Item	Specification			
Spindle speed (RPM)	5400			
Performance Specifications				
Buffer size	8 MB			
Interface	SATA			
DC Power Requirements				
Voltage tolerance	5V ±5%	5V ±5%	5V ±5%	5V ±5%

BIOS

Item	Specification
BIOS vendor	Phoenix
BIOS version	Release 4.0
BIOS ROM type	Flash
Features	<ul style="list-style-type: none"> Flash ROM 4MB Support ISIPP Support Acer UI Support multi-boot Suspend to RAM (S3)/Disk (S4) Various hot-keys for system control Support SMBIOS 2.3, PCI2.2. Refer to Acer BIOS specification. DMI utility for BIOS serial number configurable/asset tag Support PXE Support Y2K solution Support WinFlash Wake on LAN from S3 Wake on LAN form S4 in AC mode System information

LCD 15.6"

Item	Specification
Vendor/model name	AUO/Samsung/LG
Screen Diagonal (mm)	15.6 inches
Display resolution (pixels)	1366 x 768
Pixel Pitch	0.252x 0.252
Display Mode	Normally White
Typical White Luminance (cd/m ²) (also called Brightness)	200
Contrast Ratio	500 typical
Response Time (Optical Rise Time/Fall Time) msec	8/16
Luminance Uniformity	1.25 max
Electrical Interface	LVDS
Support Color	262K

Item	Specification
Viewing Angle (up/down/right/left)	15/35/45/45
Temperature Range (°C) Operating Storage (shipping)	0 to +50 -20 to +60

Bluetooth

Item	Specification
Bluetooth Controller	Bluetooth module Foxconn Bluetooth BRM 2046 BT2.1 (T60H928.33) F/W:861
Features	<ul style="list-style-type: none"> Fully Qualified Bluetooth v2.1 with Class 2 specification RF output power. Enhanced Data Rate (EDR) compliant. Full Piconet and Scatternet operation. Integrated PIFA Antenna with better RF performance. USB 2.0 compliant interface. F/W upgradable via Flash downloads. Very low power consumption. Support Coexistence with Intel WCS (Wireless Coexistence System) & AFH (Adaptive Frequency Hopping). A2DP support

Audio Codec and Amplifier

Item	Specification
Audio Controller	Realtek ALC271X-GR
Package	48-pin QFN
Features	<ul style="list-style-type: none"> Compatible with Windows Logo Program 3.10 and future requirements WaveRT-based audio function driver for Windows 7 EAX™ 1.0 & 2.0 compatible Direct Sound 3D™ compatible I3DL2 compatible HRTF 3D Positional Audio (Windows XP only) Emulation of 26 sound environments to enhance gaming experience Multi-band software equalizer and tools Voice Cancellation and Key Shifting in Karaoke mode Dynamic range control (expander, compressor, and limiter) with adjustable parameters Intuitive Configuration Panel (Realtek Audio Manager) to enhance user experience Microphone Acoustic Echo Cancellation (AEC), Noise Suppression (NS), and Beam Forming (BF) technology for voice application Smart multiple streaming operation HDMI audio driver for AMD platform Dolby® PCEE program™ (optional software feature) Fortemedia® SAM™ technology for voice processing (Beam Forming and Acoustic Echo Cancellation) (optional software feature). Acer exclusive software features

LAN Interface

Item	Specification
LAN Chipset	ATHEROS AR8151L
Package	40pin QFN
Features	<ul style="list-style-type: none">• The AR8151L is the fifth generation Gigabit Ethernet (GbE) controller solution from Atheros. It is an ultra-high performance, ultralow cost, and ultra-low power fully integrated 10/100/1000 Mbps NIC/LOM Ethernet controller perfectly suited for both PC and embedded applications.• The AR8151L combines a 10/100/1000BASE-T GbE media access controller (MAC), a triplespeed Ethernet physical layer transceiver (PHY), a PCI Express bus interface, and a 25 MHz shared-source clock input and the AR8151L contains an embedded 256 byte Onetime Program able (OTP) memory (using ondie eFuse technology) to offer an ultra-low cost solution to the Ethernet market.• The AR8151L is complsiant with IEEE 802.3u specification for 10/100 Mbps Ethernet and IEEE 802.3ab specification for 1000 Mbps Ethernet. The AR8151L device combines pulse shaping, Tx/Rx PCS, echo canceller, NEXT canceller, equalizer, decoder, and timing recovery functions to deliver robust signal performance in noisy environments.• The AR8151L GbE controller supports checksum offload features for IP, TCP, and UDP, lowering CPU utilization and optimizing network performance.• The AR8151L also supports advanced power management functions, including Wake-On- LAN (WOL) and AMD Magic Packet™.•

Keyboard

Item	Specification
Type	ACER AC7T_A10B AC7T Internal 17
Total number of keypads	103/104/107
Windows logo key	Yes
Internal & external keyboard work simultaneously	Yes
Features	<ul style="list-style-type: none">• Supports application keys for Windows 7 version

Media Card Reader

Item	Specification
Chipset	AU6437-GBL -GR
Package	LQFP
Features	<ul style="list-style-type: none">• Fully compatible with USB2.0 High Speed and backward compatible with USB1.1 specifications• Supports multiple flash card interfaces, including SD/ MMC/xD/MS.• Supports single LUN• Supports both Windows and Mac OS

Camera

Item	Specifications
Vendor and model	SUYIN/ Chicony/ Liteon
Type	CMOS image sensor with WXGA (resolution 1280X800)
Interface	USB Port
Focusing range	26.6cm ~ infinity
Dimensions (L x W x H mm)	65.0±0.3 X 8.0±0.1 X 3.69+0.11/-0.2 mm
Sensor type	1.0Mega CMOS Sensor
Pixel resolution	1280X800
Pixel size	3.0um X3.0um
Image size	3.89mm(H) X 2.43mm(V)Part number

Wireless LAN

	Specification	Specification	Specification
Type	Atheros HB95	Atheros HB93	Intel MM#903341
Wireless Standards Supported	b, g	b, g, n	b, n

Battery

Item	Specification
Vendor & model name	Simplo, Panasonic, SAMSUNG AS2010B, Sanyo AS10B,
Battery Type	Li-ion
Pack capacity	SAMSUNG 4400mAh
Number of battery cell	6
Package configuration	3 cells in series, 2 series in parallel

System Utilities

BIOS Setup Utility

The BIOS Setup Utility is a hardware configuration program built into your computer's BIOS (Basic Input/Output System).

Your computer is already properly configured and optimized, and you do not need to run this utility. However, if you encounter configuration problems, you may need to run Setup. Please also refer to Chapter 4 Troubleshooting when problem arises.

To activate the BIOS Utility, press **F2** during POST (when **Press <F2> to enter Setup** message is prompted on the bottom of screen).

Press **F2** to enter setup. The default parameter of F12 Boot Menu is set to "disabled". If you want to change boot device without entering BIOS Setup Utility, please set the parameter to "enabled".

Press **<F12>** during POST to enter multi-boot menu. In this menu, user can change boot device without entering BIOS SETUP Utility.

Navigating the BIOS Utility

There are five menu options: Information, Main, Security, Boot, and Exit.

Follow these instructions:

- To choose a menu, use the left and right arrow keys.
- To choose an item, use the up and down arrow keys.
- To change the value of a parameter, press **F5** or **F6**.
- A plus sign (+) indicates the item has sub-items. Press **Enter** to expand this item.
- Press **Esc** while you are in any of the menu options to go to the Exit menu.
- In any menu, you can load default settings by pressing **F9**. You can also press **F10** to save any changes made and exit the BIOS Setup Utility.

NOTE: You can change the value of a parameter if it is enclosed in square brackets. Navigation keys for a particular menu are shown on the bottom of the screen. Help for parameters are found in the Item Specific Help part of the screen. Read this carefully when making changes to parameter values. **Please note that system information is subject to different models.**

Information

The Information screen displays a summary of your computer hardware information.

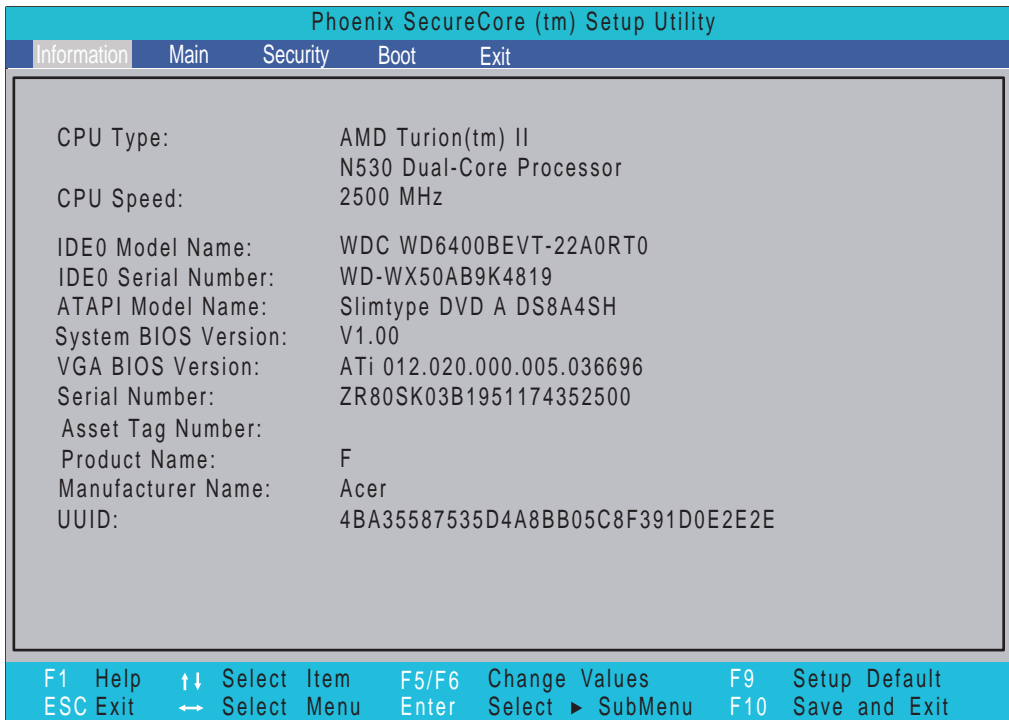

NOTE: The system information is subject to different models.

Parameter	Description
CPU Type	This field shows the CPU type and speed of the system.
CPU Speed	This field shows the speed of the CPU.
IDE0 Model Name	This field shows the model name of HDD installed on primary IDE master.
IDE0 Serial Number	This field displays the serial number of HDD installed on primary IDE master.
ATAPI Model Name	This field displays the model name of the installed ODD drive.
System BIOS Version	Displays system BIOS version.
VGA BIOS Version	This field displays the VGA firmware version of the system.
Serial Number	This field displays the serial number of this unit.
Asset Tag Number	This field displays the asset tag number of the system.
Product Name	This field shows product name of the system.
Manufacturer Name	This field displays the manufacturer of this system.
UUID Number	Universally Unique Identifier (UUID) is an identifier standard used in software construction, standardized by the Open Software Foundation (OSF) as part of the Distributed Computing Environment (DCE).

Main

The Main screen allows the user to set the system time and date as well as enable and disable boot option and recovery.

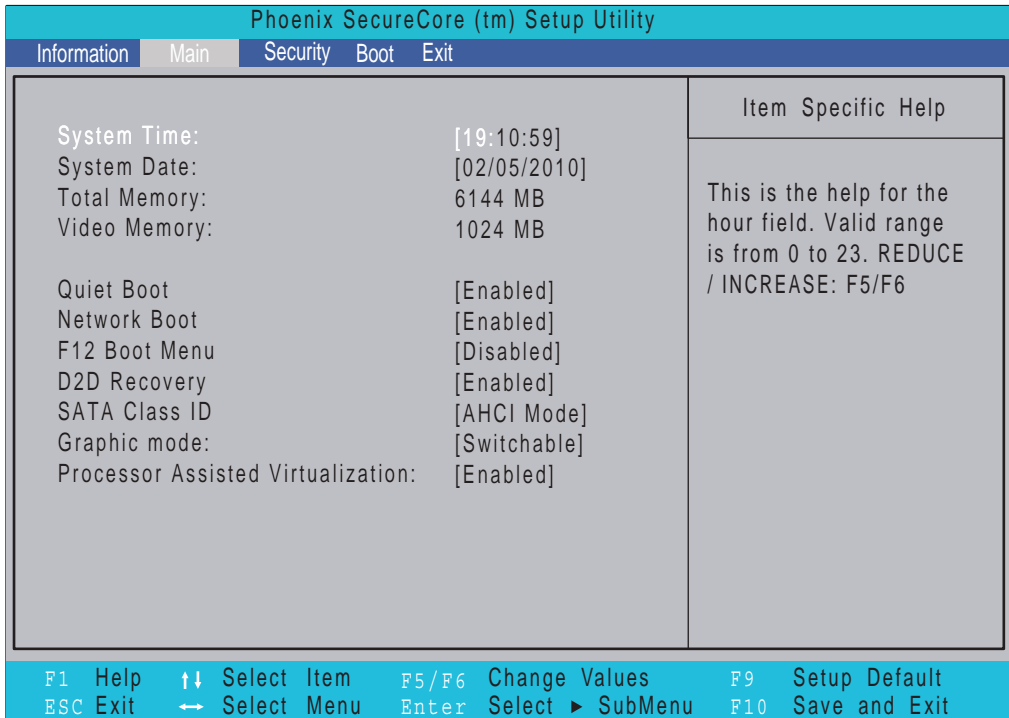

NOTE: The screen above is for your reference only. Actual values may differ.

The table below describes the parameters in this screen. Settings in **boldface** are the default and suggested parameter settings.

Parameter	Description	Format/Option
System Time	Sets the system time. The hours are displayed with 24-hour format.	Format: HH:MM:SS (hour:minute:second)
System Date	Sets the system date.	Format MM/DD/YYYY (month/day/year)
Total Memory	This field reports the memory size of the system. Memory size is fixed to 4096MB.	N/A
Video Memory	Shows the video memory size. VGA Memory size=32 MB	N/A
Quiet Boot	This will hide POST messages while booting.	Option: Enabled or Disabled
Network Boot	Enables, disables the system boot from LAN (remote server).	Option: Enabled or Disabled
F12 Boot Menu	Enables, disables Boot Menu during POST.	Option: Disabled or Enabled
D2D Recovery	Enables, disables D2D Recovery function. The function allows the user to create a hidden partition on hard disc drive to store operation system and restore the system to factory defaults.	Option: Enabled or Disabled
SATA Class ID	Control the mode in which the SATA controller should operate.	Option: AHCI mode or IDE mode
Graphic mode	Controls the graphics mode. Note: this option is only available on discrete systems	Option: Switchable or Discrete

Parameter	Description	Format/Option
Processor Assisted Virtualization	Enables, disables processor assisted virtualization. Note: this option is only available on CPUs that support this function.	Option: Enabled or Disabled

Security

The Security screen contains parameters that help safeguard and protect your computer from unauthorized use.

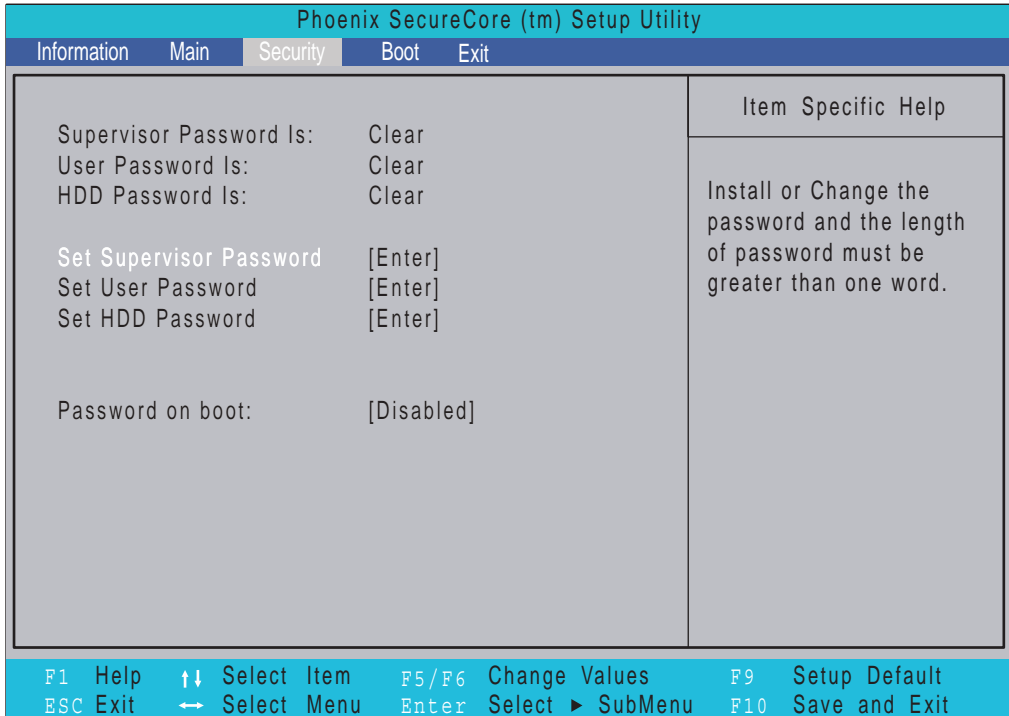

The table below describes the parameters in this screen. Settings in **boldface** are the default and suggested parameter settings.

Parameter	Description	Option
Supervisor Password Is	Shows the setting of the Supervisor password	Clear or Set
User Password Is	Shows the setting of the user password.	Clear or Set
HDD Password Is	Shows the setting of the user password	Clear or Set
Set Supervisor Password	Press Enter to set the supervisor password. When set, this password protects the BIOS Setup Utility from unauthorized access. The user can not either enter the Setup menu nor change the value of parameters.	N/A
Set User Password	Press Enter to set the user password. When user password is set, this password protects the BIOS Setup Utility from unauthorized access. The user can enter Setup menu only and does not have right to change the value of parameters.	N/A
Set HDD Password	Press Enter to set the HDD password. When set this protects the HDD from unauthorized access.	N/A
Password on boot	Defines whether a password is required or not while the events defined in this group happened. The sub-options all require the Supervisor password for changes and should be grayed out if the user password was used to enter setup.	Disabled or Enabled

NOTE: When you are prompted to enter a password, you have three tries before the system halts. Don't forget the password. If you forget the password, you may have to reset the computer.

Setting a Password

Follow these steps as you set the user or the supervisor password:

1. Use the ↑ and ↓ keys to highlight the Set Supervisor Password parameter and press the **Enter** key. The Set Supervisor Password box appears:

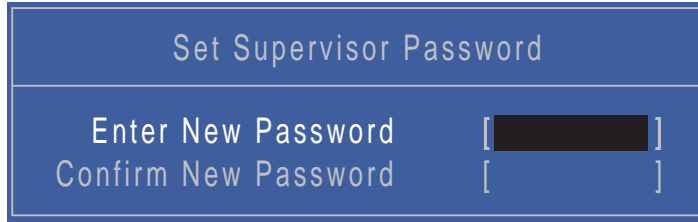

Set Supervisor Password	
Enter New Password	[██████████]
Confirm New Password	[]

2. Type a password in the “Enter New Password” field. The password length can not exceeds 8 alphanumeric characters (A-Z, a-z, 0-9, not case sensitive). Retype the password in the “Confirm New Password” field.

IMPORTANT: Be very careful when typing your password because the characters do not appear on the screen.

3. Press **Enter**. After setting the password, the computer sets the User Password parameter to “Set”.
4. If desired, you can opt to enable the Password on boot parameter.
5. When you are done, press F10 to save the changes and exit the BIOS Setup Utility.

Removing a Password

Follow these steps:

1. Use the ↑ and ↓ keys to highlight the Set Supervisor Password parameter and press the **Enter** key. The Set Password box appears:



Set Supervisor Password	
Enter Current Password	[██████████]
Enter New Password	[]
Confirm New Password	[]

2. Type the current password in the Enter Current Password field and press **Enter**.
3. Press **Enter** twice **without** typing anything in the Enter New Password and Confirm New Password fields. The computer then sets the Supervisor Password parameter to “Clear”.
4. When you have changed the settings, press u to save the changes and exit the BIOS Setup Utility.

Changing a Password

1. Use the ↑ and ↓ keys to highlight the Set Supervisor Password parameter and press the **Enter** key. The Set Password box appears.

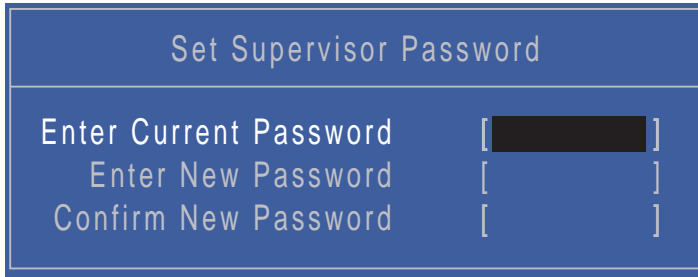

The screenshot shows a blue BIOS screen titled "Set Supervisor Password". It contains three input fields: "Enter Current Password", "Enter New Password", and "Confirm New Password". The first field is filled with blacked-out characters, while the other two are empty.

2. Type the current password in the Enter Current Password field and press **Enter**.
3. Type a password in the Enter New Password field. Retype the password in the Confirm New Password field.
4. Press **Enter**. After setting the password, the computer sets the User Password parameter to "Set".
5. If desired, you can enable the Password on boot parameter.
6. When you are done, press **F10** to save the changes and exit the BIOS Setup Utility.

If the verification is OK, the screen will display as following.



The screenshot shows a white BIOS screen titled "Setup Notice". The text "Changes have been saved." is displayed in the center. At the bottom, there is a black button labeled "Continue".

The password setting is complete after the user presses **Enter**.

If the current password entered does not match the actual current password, the screen will show you the Setup Warning.



The screenshot shows a white BIOS screen titled "Setup Warning" in red text. Below the title, the text "Invalid Password." is displayed in red. At the bottom, there is a black button labeled "Continue".

If the new password and confirm new password strings do not match, the screen displays the following message.



The screenshot shows a white BIOS screen titled "Setup Warning" in red text. Below the title, the text "Passwords do not match. Re-enter password." is displayed in red. At the bottom, there is a black button labeled "Continue".

Boot

This menu allows the user to decide the order of boot devices to load the operating system. Bootable devices includes the USB diskette drives, the onboard hard disk drive and the DVD drive in the module bay.

Phoenix SecureCore (tm) Setup Utility				
Information	Main	Security	Boot	Exit
Boot priority order:		Item Specific Help		
1. IDE HDD : WDC WD6400BEVT-22A0RT0		Use <↑> or <↓> to select a device, then press <F5> to move it down the list, or <F6> to move it up the list. Press <Esc> to escape the menu		
2. IDE CD : HL-DT-STDVDRAM GT30N				
3. USB FDC :				
4. PCI BEV : Atheros Boot Agent				
5. USB HDD :				
6. USB CDROM :				
7. USB FDC:				
8. USB KEY:				
Excluded from boot order:				
F1 Help	↑↓ Select Item	F5/F6 Change Values	F9 Setup Default	
ESC Exit	←→ Select Menu	Enter Select ► SubMenu	F10 Save and Exit	

Exit

The Exit screen allows you to save or discard any changes you made and quit the BIOS Utility.

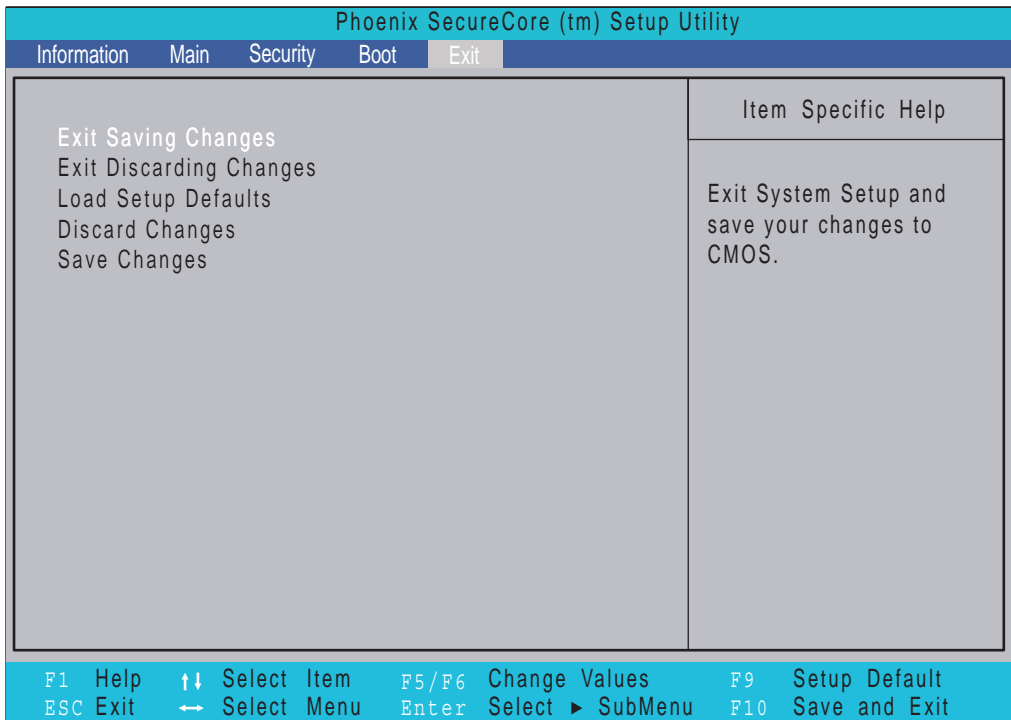

The table below describes the parameters in this screen.

Parameter	Description
Exit Saving Changes	Exit System Setup and save your changes to CMOS.
Exit Discarding Changes	Exit utility without saving setup data to CMOS.
Load Setup Default	Load default values for all SETUP item.
Discard Changes	Load previous values from CMOS for all SETUP items.
Save Changes	Save Setup Data to CMOS.

BIOS Flash Utility

The BIOS flash memory update is required for the following conditions:

- New versions of system programs
- New features or options
- Restore a BIOS when it becomes corrupted.

DOS Flash Utility

Perform the following steps to use the DOS Flash Utility:

1. Press F2 during boot to enter the Setup Menu.
2. Select **Boot Menu** to modify the boot priority order, for example, if using USB HDD to Update BIOS, move USB HDD to position 1.

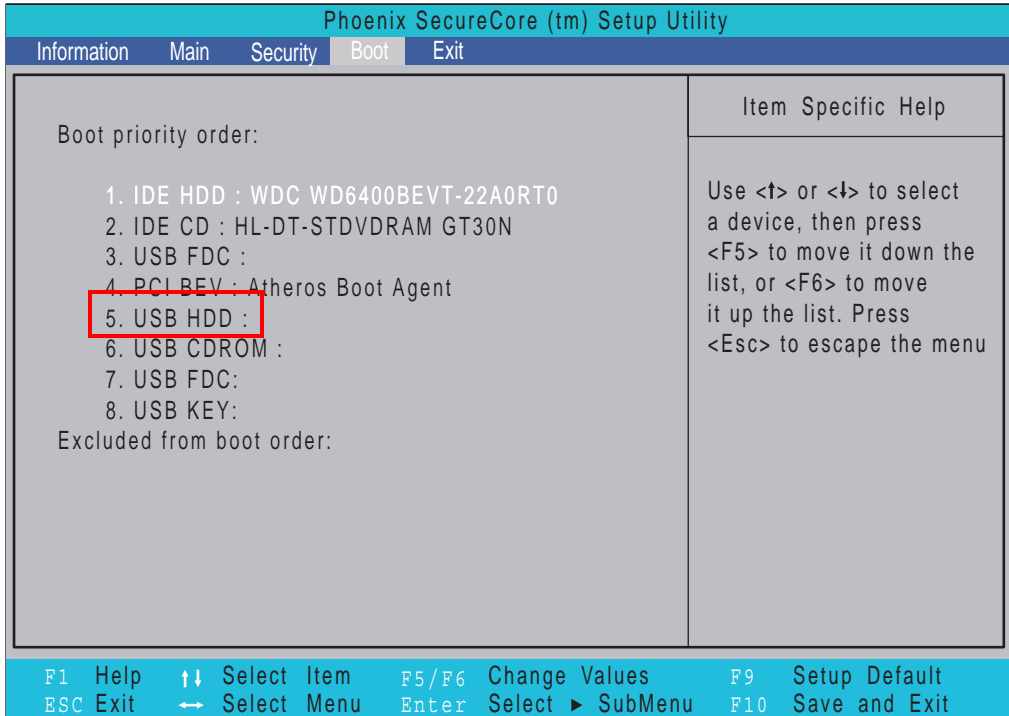

3. Execute the **FLASH.BAT** batch file to update BIOS. Or enter C:\ **Flash it bios ver.f/d/c**

The flash process begins as shown.



4. In flash BIOS, the message **Please do not remove AC Power Source** displays.

NOTE: If the AC power is not connected, the following message displays.



5. Plug in the AC power to continue.

-
6. Flash is complete when the message Flash programming complete displays.

WinFlash Utility

Perform the following steps to use the WinFlash Utility:

1. Double click the WinFlash executable.
2. Click **OK** to begin the update. WinFlash closes all applications and shuts down the system.

NOTE: Place only one *.wph file with flash32.exe in the same folder when executing this procedure and reboot the system.

Remove HDD/BIOS Password Utilities

This section provide you with removing HDD/BIOS method:

Remove HDD Password:

When the user keys in the wrong password three times, the system reports the following error code to user.



To unlock the HDD password, perform the following steps:

1. Press **Enter** to display the Select Item screen.

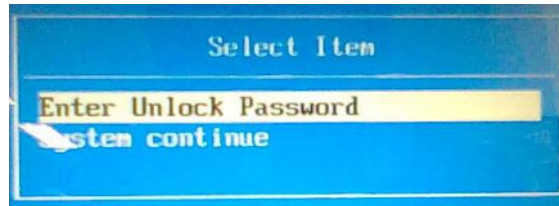

2. Select **Enter Unlock Password** and press **Enter**.

An Unlock Password displays.



3. Make a note of the key, **76943488** in the example.
4. Boot up the system to a removable bootable drive containing DOS and the UnlockHD.EXE program and open a DOS prompt. For instructions on changing boot priority see "Boot" on page 40.
5. From the DOS prompt, enter the **UnlockHD.EXE** command and input the key to create an unlock code. Make a note of the result, for example **46548274**.
6. Reboot to the hard disk and wait for the error code to reappear.
7. Press **Enter** to display the Select Item screen.
8. Select **Enter Unlock Password** and press **Enter**.
9. Enter the unlock code generated by UnlockHD.EXE.
10. Save and exit the BIOS to complete the process.

Removing BIOS Passwords:

If you key in the wrong Supervisor Password three times, System Disabled displays on the screen. See the image below.

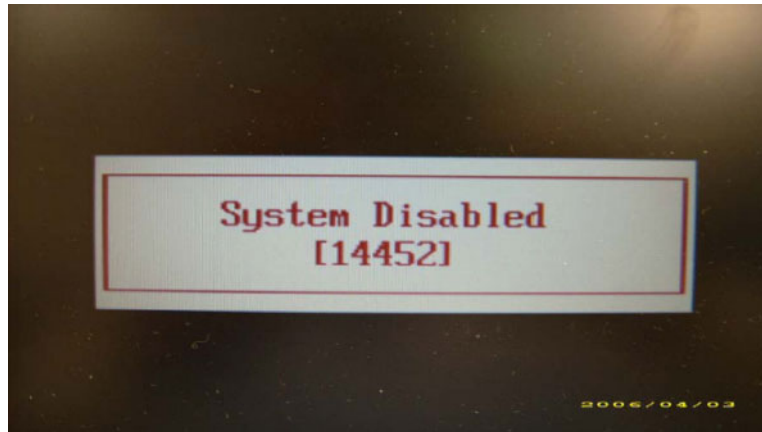

To reset the BIOS password, run clnpwd.exe as follows:

1. From a DOS prompt, Execute **clnpwd.exe**

```
d:\Clnpwd>clnpwd
ACER Clean Password Utility V1.00
Press 1 or 2 to clean any password shown as below
    1.User Password
    2.Supervisor Password

Clean User Password Successfully!
```

2. Press 1 or 2 to clean the desired password shown on the screen.

The onscreen message determines whether the function is successful or not.

Miscellaneous Utilities

Using Boot Sequence Selector

Boot Sequence Selector allows the boot order to be changes without accessing the BIOS. To use Boot Sequence Selector, perform the following steps:

1. Enter into DOS.
2. Execute BS.exe to display the usage screen.

```
d:\B00TSEQ>bs
*** Boot Sequence Selector Version 0.03 ***
Create by Rockwell Chuang 10/01/2005.
Usage:
      BS [ 1 | 2 | 3 | 4 ]
BS 1 : [ Floppy ] => [ HardDisk ] => [ CD-ROM ] => [ LAN   ]
BS 2 : [ HardDisk ] => [ CD-ROM ] => [ LAN   ] => [ Floppy ]
BS 3 : [ CD-ROM ] => [ HardDisk ] => [ LAN   ] => [ Floppy ]
BS 4 : [ LAN   ] => [ Floppy ] => [ HardDisk ] => [ CD-ROM ]
d:\B00TSEQ>
```

3. Select the desired boot sequence by entering the corresponding sequence, for example, enter BS2 to change the boot sequence to HDD|CD ROM|LAN|Floppy.

Using DMITools

The DMI (Desktop Management Interface) Tool copies BIOS information to eeprom to be used in the DMI pool for hardware management.

When the BIOS displays **Verifying DMI pool data** it is checking the table correlates with the hardware before sending to the operating system (Windows, etc.).

To update the DMI Pool, perform the following steps:

1. Enter into DOS.
2. Execute **dmitools.exe**. The following messages show dmitools usage:

```
*** Compal DMI String R/W Utility Ver1.40 for 2006/03/14 ***

Usage:

DMITOOLS [ /R | /WP | /WS | /WU ] [ STRING ]

[R]   : Read DMI Information from Memory
[WM]  : Write Manufacturer Name to EEPROM. (Max.= 16 characters)
[WP]  : Write Product Name to EEPROM.      (Max.= 16 characters)
[WS]  : Write Serial Number to EEPROM      (Max.= 22 characters)
[WU]  : Write UUID to EEPROM.              (Ignore String   )
[WA]  : Write Asset Tag to EEPROM.         (Max.= 32 characters)
```

IMPORTANT:The following write examples (2 to 5) require a system reboot to take effect

Example 1: Read DMI Information from Memory

Input:

```
dmitools /r
```

Output:

```
Manufacturer (Type1, Offset04h): Acer  
Product Name (Type1, Offset05h): Aspire one xxxxx  
Serial Number (Type1, Offset07h): 01234567890123456789  
UUID String (Type1, Offset08h): xxxxxxxx-xxxx-xxxx-xxxx-xxxxxxxxxxxx  
Asset Tag (Type3, Offset04h): Acer Asstag
```

Example 2: Write Product Name to EEPROM

Input:

```
dmitools /wp Acer
```

Example 3: Write Serial Number to EEPROM

Input:

```
dmitools /ws 01234567890123456789
```

Example 4: Write UUID to EEPROM

Input:

```
dmitools /wu
```

Example 5: Write Asset Tag to EEPROM

Input:

```
dmitools /wa Acer Asstag
```

Using the LAN MAC Utility

Perform the following steps to write MAC information to eeprom:

1. Use a text editor, for example Notepad, to edit the MAC.CFG file as shown:

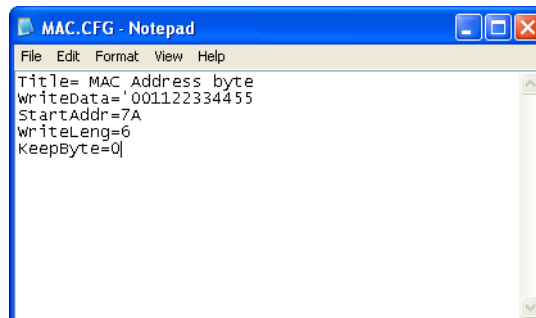

- WriteData= '001122334455' <----- MAC value
 - StartAddr=7A <----- MAC address
 - WriteLeng=6 <----- MAC value length
 - KeepByte=0 <----- can be any value
2. Boot into DOS.
 3. Execute **MAC.BAT** to write MAC information to eeprom.

Machine Disassembly and Replacement

This chapter contains step-by-step procedures on how to disassemble the notebook computer for maintenance and troubleshooting.

Disassembly Requirements

To disassemble the computer, you need the following tools:

- Wrist grounding strap and conductive mat for preventing electrostatic discharge
- Flat screwdriver
- Philips screwdriver
- Plastic flat screwdriver
- Plastic tweezers

NOTE: The screws for the different components vary in size. During the disassembly process, group the screws with the corresponding components to avoid mismatch when putting back the components.

Related Information

The product previews seen in the disassembly procedures may not represent the final product color or configuration.

IMPORTANT: Cable paths and positioning may not represent the actual model. During the removal and replacement of components, ensure all available cable channels and clips are used and that the cables are replaced in the same position.

Replacement Requirements

NOTE: Cabling and components require adhesive to be applied during the replacement and reassembly process.

NOTE: During manufacture a cyanoacrylate glue is used provided by Holdtite Adhesives LTD. This is not a specified requirement. The reassembler is free to select an alternative appropriate adhesive.

Pre-disassembly Instructions

Before proceeding with the disassembly procedure, make sure that you do the following:

1. Turn off the power to the system and all peripherals.
2. Unplug the AC adapter and all power and signal cables from the system.



3. Place the system on a flat, stable surface.

Disassembly Process

The disassembly process is divided into the following sections:

- External components disassembly
- Main unit disassembly
- LCD module disassembly

The flowcharts provided in the succeeding disassembly sections illustrate the entire disassembly sequence. Observe the order of the sequence to avoid damage to any of the hardware components. For example, if you want to remove the Mainboard, you must first remove the Keyboard, and LCD Module then disassemble the inside assembly frame in that order.

Main Screw List

Screw	Quantity	Acer Part Number
M2.5*5	32	86.ARE07.003
M2*3Ni	4	86.A08V7.005
M2.5*4	2	86.PTN07.004
M2.5*4Ni	7	86.EDM07.003
M2.5*3	9	86.PTN07.003
T2.5*2	5	86.B1907.005
M3*3Ni	2	86.N1407.007
M2*3	3	86.ARE07.002

External Module Disassembly Process

NOTE: The product previews seen in the disassembly procedures may not represent the final product color or configuration.

Screw List

Step	Screw	Quantity	Part No.
Base Cover Disassembly	M2.5*5	8	86.ARE07.003
WLAN Module Disassembly	M2.0*3Ni	1	86.A08V7.005
HDD Disassembly	M3*3Ni	2	86.N1407.007
ODD Module Disassembly	M2*3	2	86.A08V7.005

External Modules Disassembly Flowchart

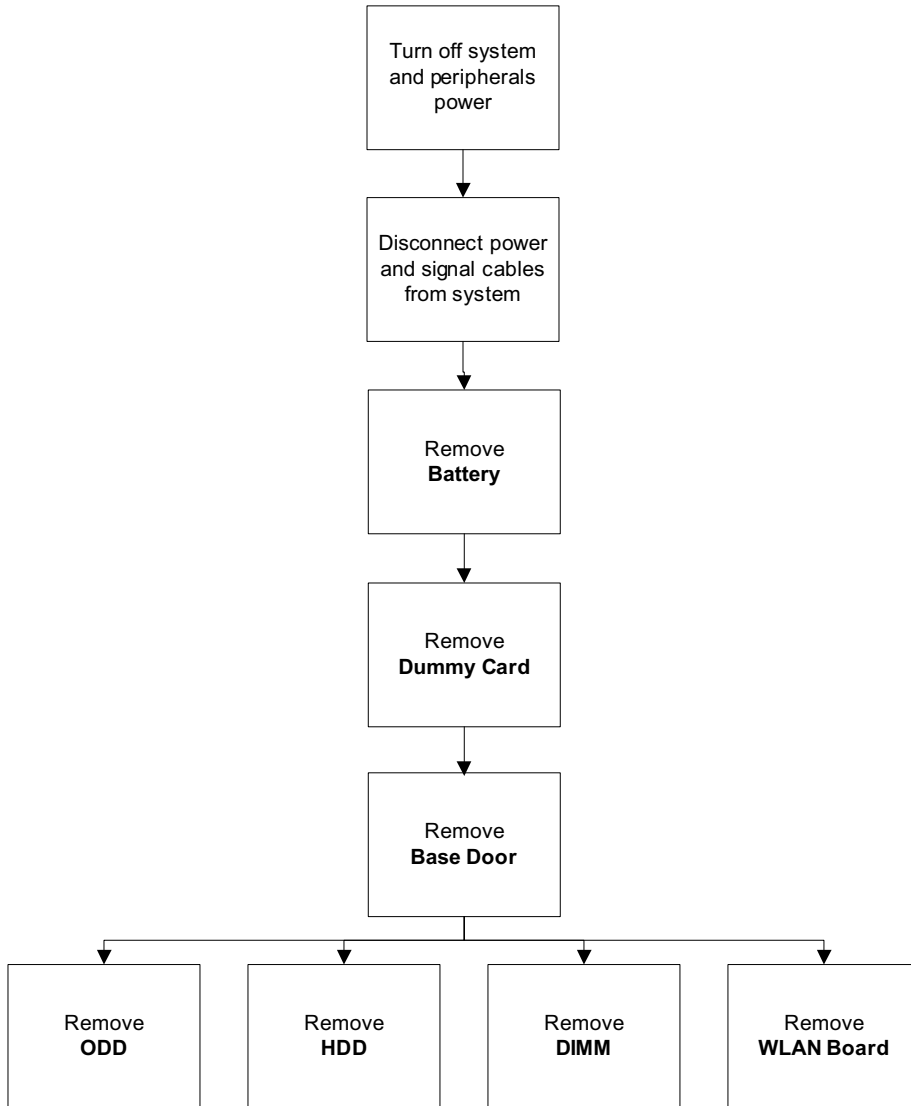

Removing the Battery Pack

1. Turn the computer over.
2. Slide the battery lock/unlock latch to the unlock position.



3. Slide and hold the battery release latch to the release position (1), then slide out the battery pack from the main unit (2).

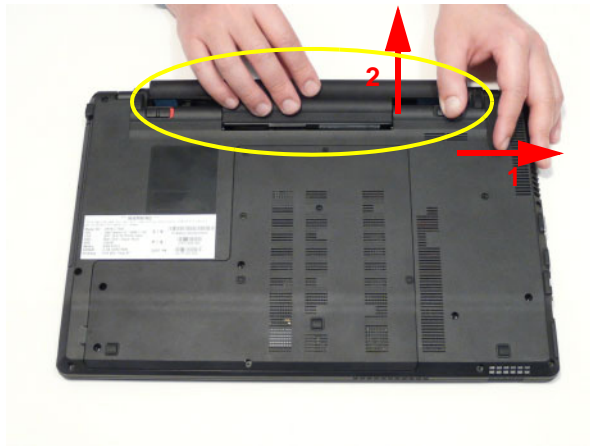

NOTE: The battery has been highlighted with a yellow oval as shown in the above image. Please detach the battery and follow local regulations for disposal.

Removing the Dummy Card

1. Press the dummy card in to allow it to spring out.





2. Pull the dummy card out.

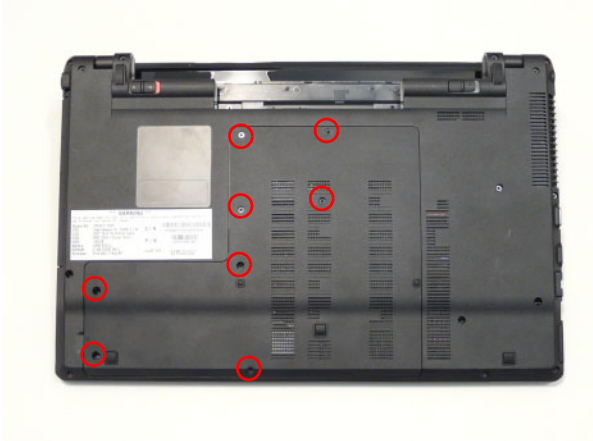

Removing the Base Door

- 1. See "Removing the Battery Pack" on page 54.
- 2. Remove the eight (8) screws.



Step	Screw	Quantity	Screw Type
Base Door Disassembly	M2.5*5	8	

- 3. Lift the base door up at the finger indentation location provided in the bottom cover.

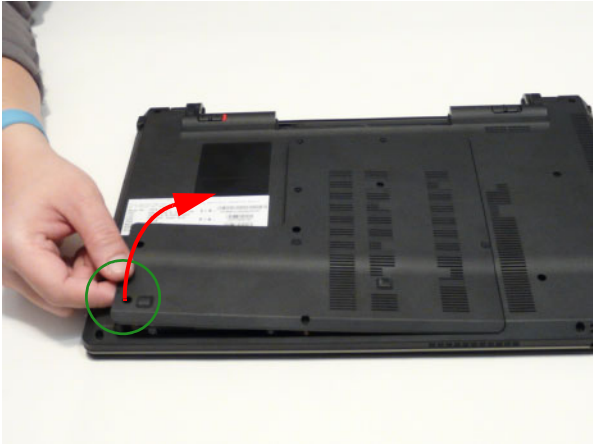

-
4. Lift the base door out and away.

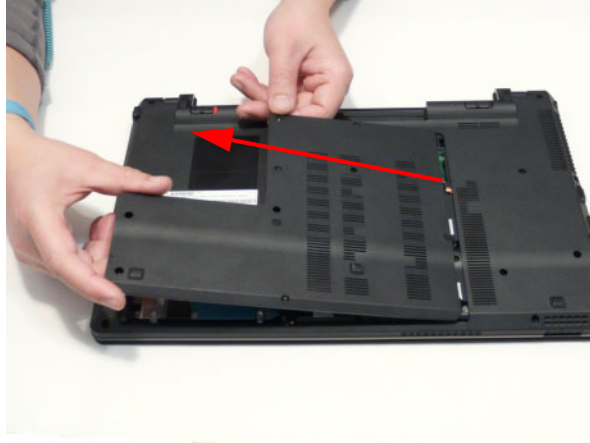

Removing the Hard Disk Drive Module

1. See “Removing the Battery Pack” on page 54.
2. See “Removing the Base Door” on page 56.
3. Grasp the pull tab on the top of the HDD.



4. Pull the tab horizontally to slide the HDD out of the connector dock.

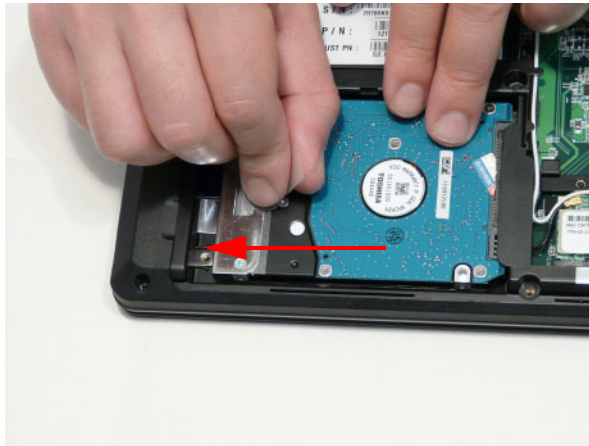

5. Lift the HDD out.

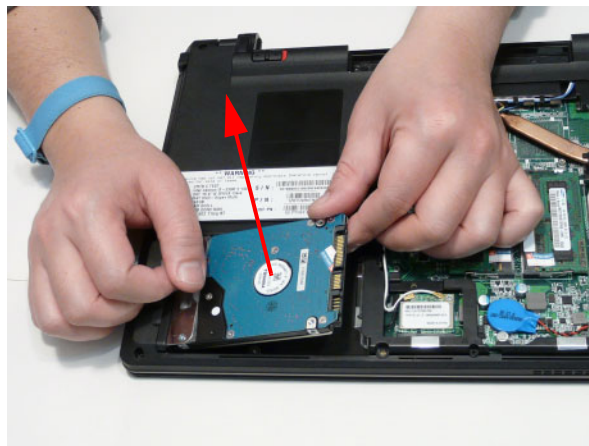

6. Remove the two (2) screws of the HDD bracket.

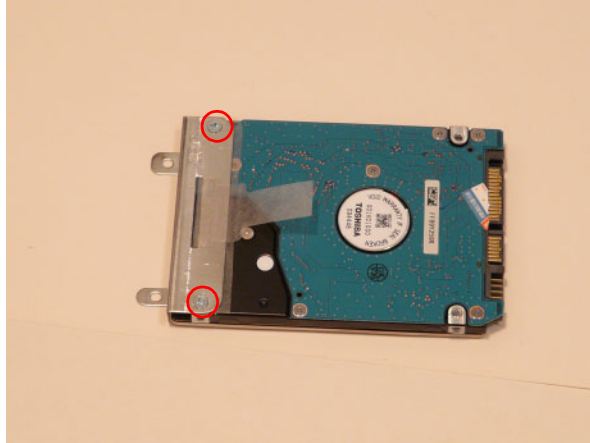

Step	Screw	Quantity	Screw Type
HDD Bracket Disassembly	M3*3Ni	2	

7. Lift the bracket away from the HDD.

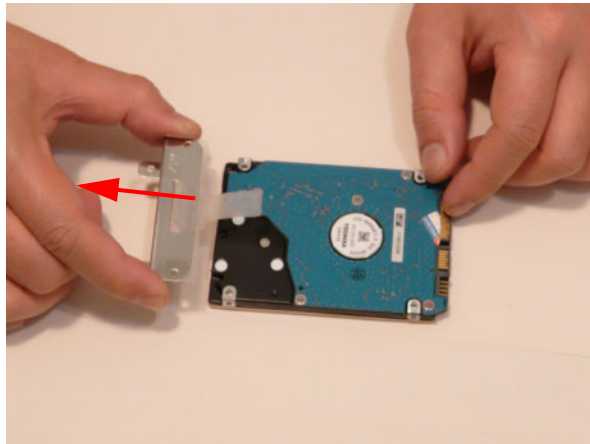

Removing the DIMM Module

1. See “Removing the Battery Pack” on page 54.
2. See “Removing the Base Door” on page 56.
3. Push the memory module clips outwards.

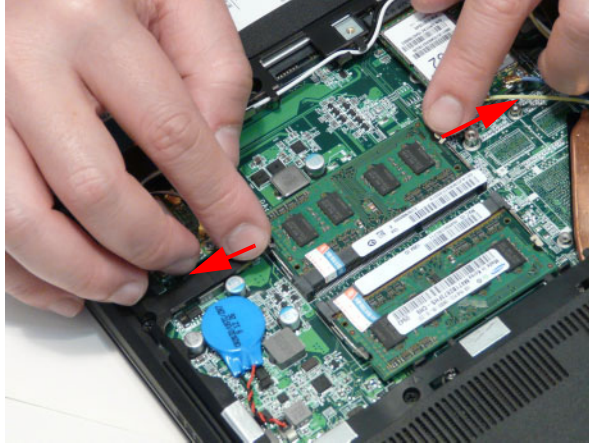

4. Pull the memory module out.



Removing the WLAN Module

1. See “Removing the Battery Pack” on page 54.
2. See “Removing the Base Door” on page 56.
3. Detach the two (2) cables from the Wireless LAN module.

IMPORTANT: Take note of the Main (black cable connecting to pcb socket 1) and Auxiliary (white cable connecting to pcb socket 2) connectors.



4. Remove the one (1) screw. Ensure the cables are well clear of the module.



Step	Screw	Quantity	Screw Type
WLAN Module Disassembly	M2.0*3Ni	1	

-
5. Pull the WLAN module out and away.

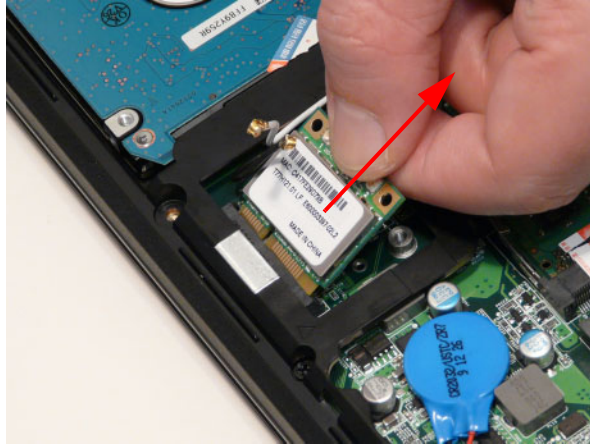

Removing the ODD Module

1. See “Removing the Battery Pack” on page 54.
2. See “Removing the Base Door” on page 56.
3. Push the ODD module out of the bay at the location shown.



4. Pull the ODD completely out of the bay.

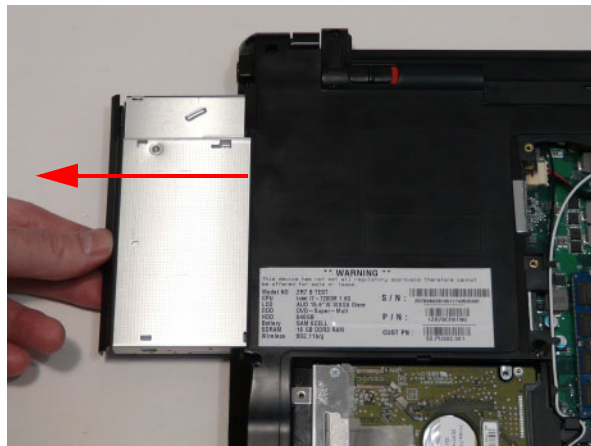

5. Remove the two (2) screws of the ODD bracket.



Step	Screw	Quantity	Screw Type
ODD Module Disassembly	M2*3Ni	2	

6. Remove the ODD bracket.

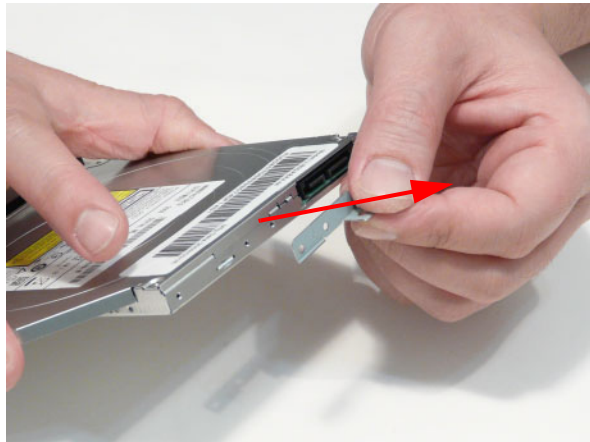

7. Pry the ODD bezel off the ODD module.



Removing the RTC Battery

1. See “Removing the Battery Pack” on page 54.
2. See “Removing the Base Door” on page 56.
3. Disconnect the RTC connector.

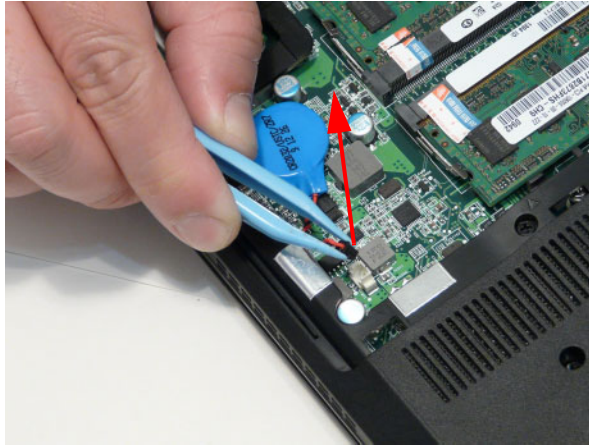

4. Pull the RTC battery off the mainboard.

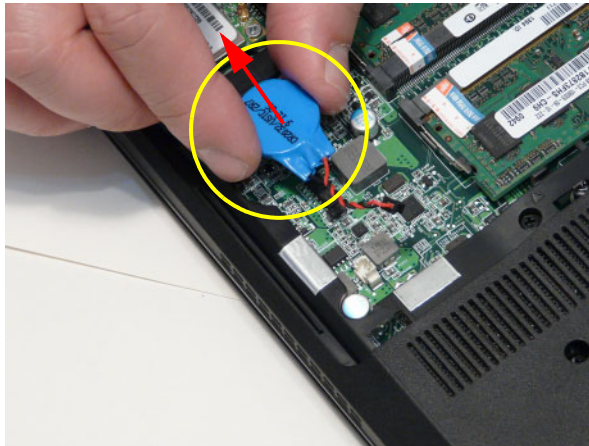

NOTE: The RTC battery has been highlighted with the yellow circle as shown in the previous image. Please detach the RTC battery and follow local regulations for disposal.

Main Unit Disassembly Process

IMPORTANT: Cable paths and positioning may not represent the actual model. During the removal and replacement of components, ensure all available cable channels and clips are used and that the cables are replaced in the same position.

NOTE: The product previews seen in the disassembly procedures may not represent the final product color or configuration.

Main Unit Disassembly Flowchart

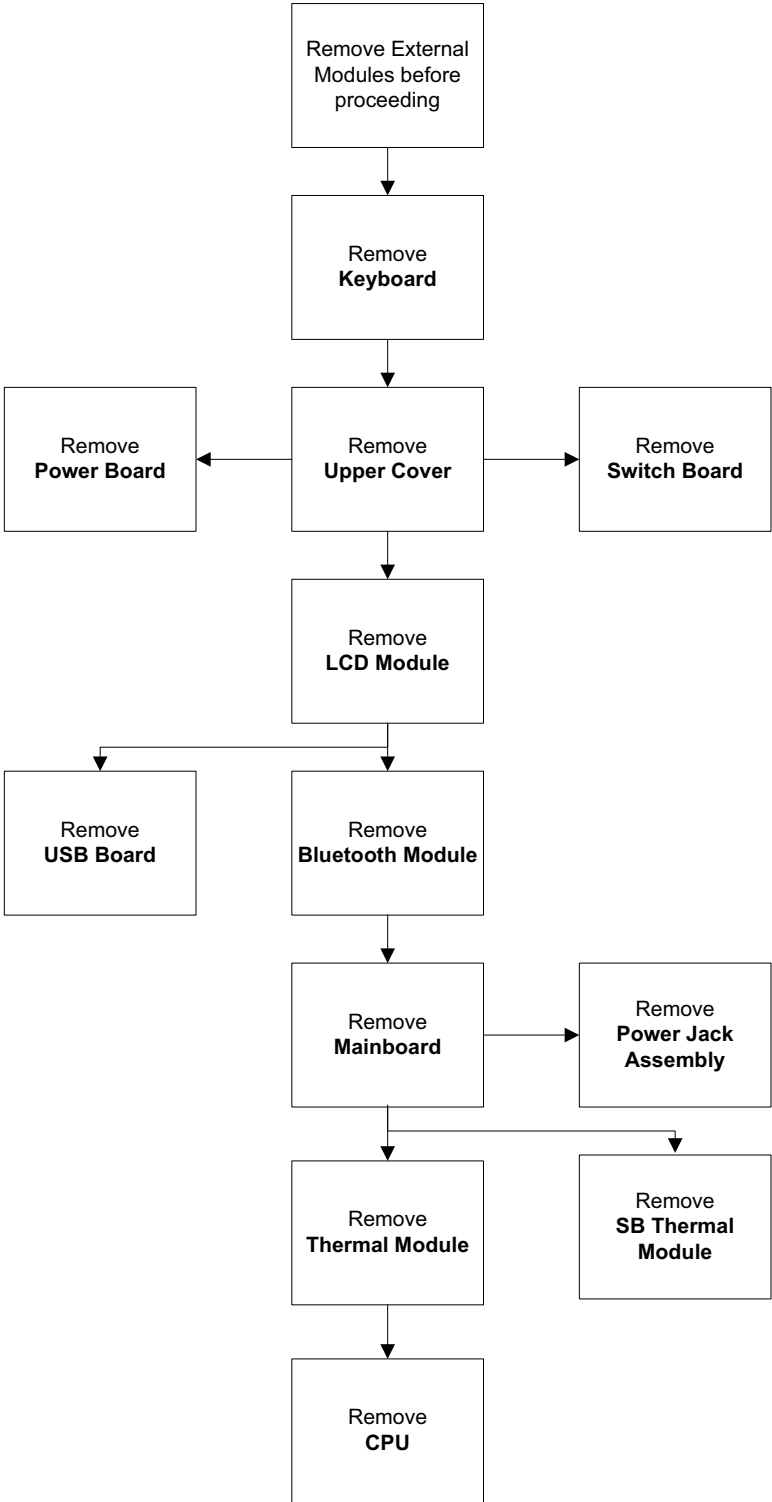

Screw List

Step	Screw	Quantity	Part No.
Upper Cover Disassembly	M2.5*4Ni	6	86.EDM07.003
	M2.0*3	3	86.A08V7.005
Lower Cover Disassembly	M2.5*5	20	86.ARE07.003
	T2.5*2Ni	1	86.B1907.005
Switch Board Disassembly	T2.5*2Ni	2	86.B1907.005
Power Module Disassembly	T2.5*2Ni	2	86.B1907.005
USB Board Disassembly	M2.5*5	1	86.ARE07.003
Bluetooth Module Disassembly	M2.0*3	1	86.A08V7.005
Mainboard Disassembly	M2.5*5	1	86.ARE07.003
Power Jack Assembly Disassembly	M2.5*4	1	86.EDM07.003

Removing the Keyboard

IMPORTANT: The keyboard is easily warped or damaged during the removal process. Take care not to use excessive force when removing to prevent damage.

1. See “Removing the Battery Pack” on page 54.
2. See “Removing the Base Door” on page 56.
3. See “Removing the DIMM Module” on page 60.
4. See “Removing the WLAN Module” on page 61.
5. See “Removing the ODD Module” on page 63.
6. Using the plastic pry, press in the five (5) latches along the top of the keyboard to release the keyboard from the cover.

NOTE: The keyboard will spring up slightly when all retaining clips are unlocked.



7. Lift up the top right edge of the keyboard and then lift the keyboard up.

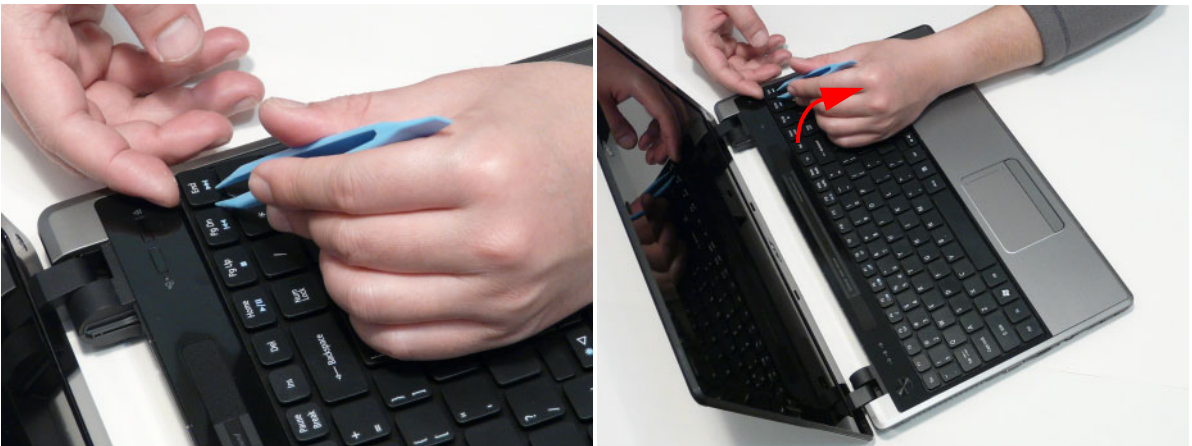

8. Flip the keyboard over.



9. Detach the keyboard FPC.

a. Unlock the FPC

b. Pull the keyboard away

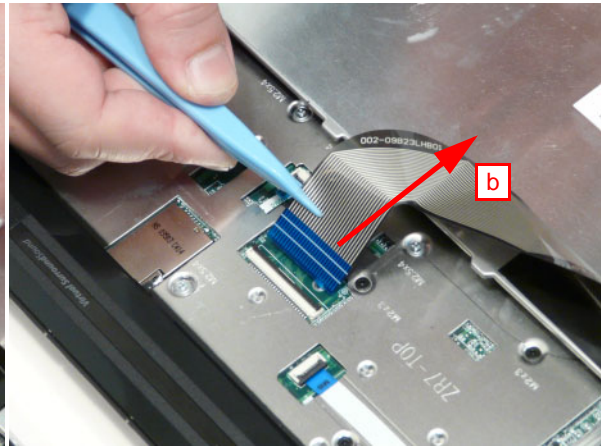
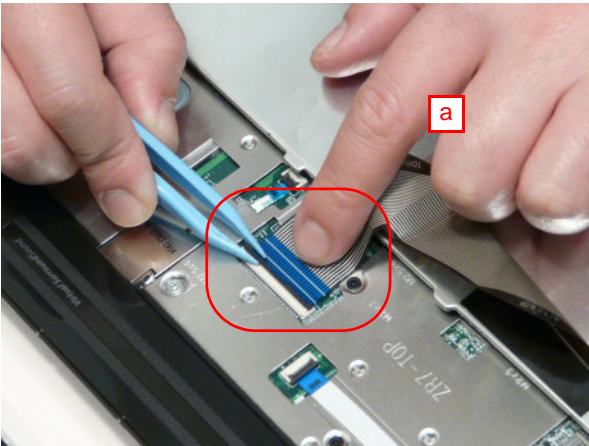

Removing the Upper Cover

1. See "Removing the Keyboard" on page 69.
2. Unlock and disconnect the Touchpad board FFC.

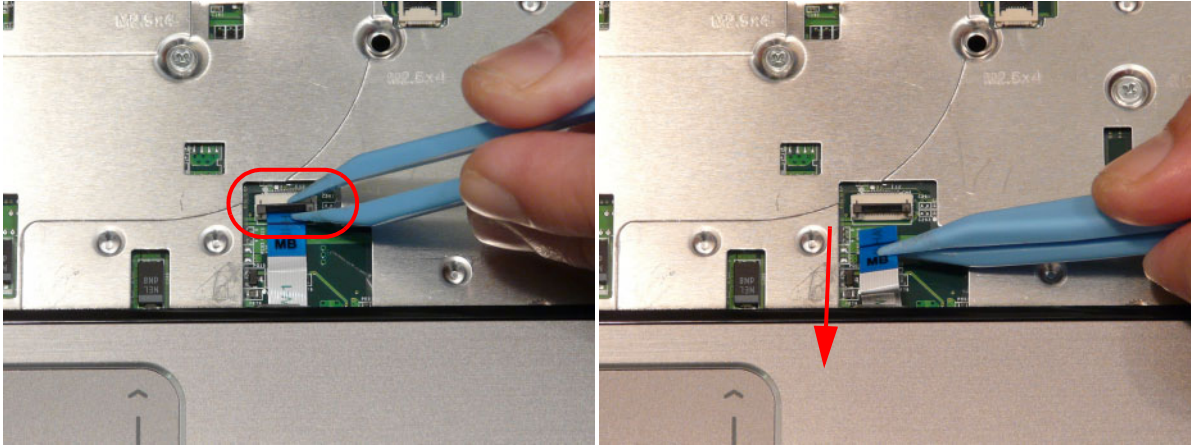

3. Unlock and disconnect the switch board FFC.

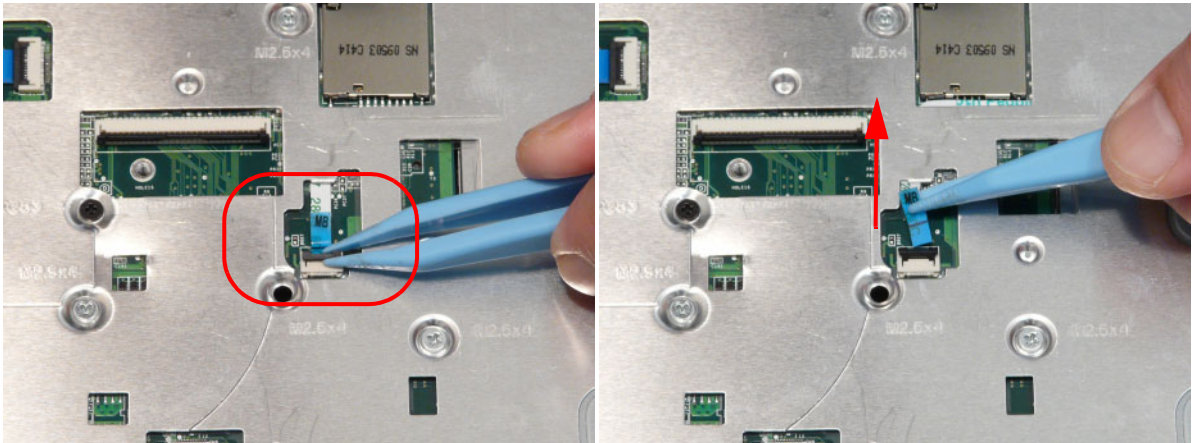

4. Unlock and disconnect the power board FFC.

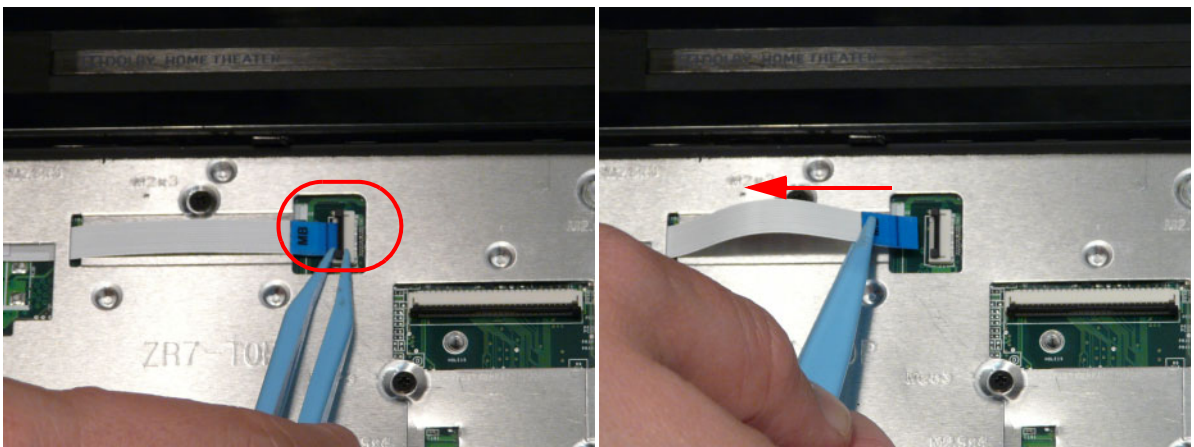

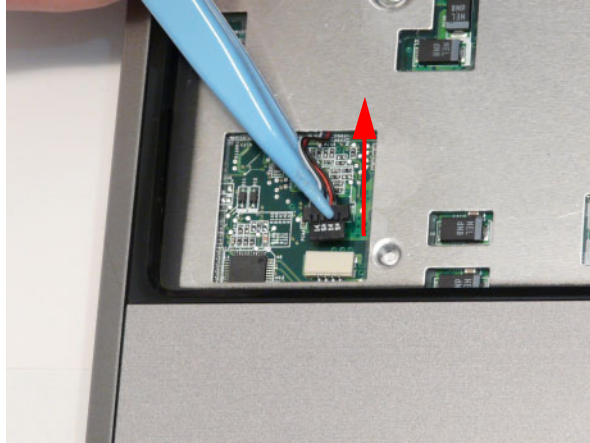

5. Disconnect the speaker cable.



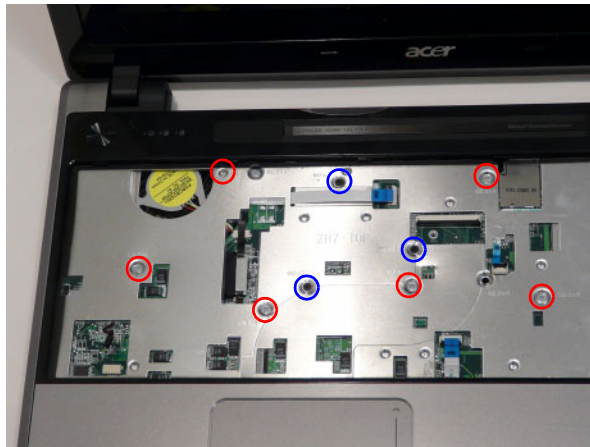

6. Remove the nine (9) screws in the upper cover.

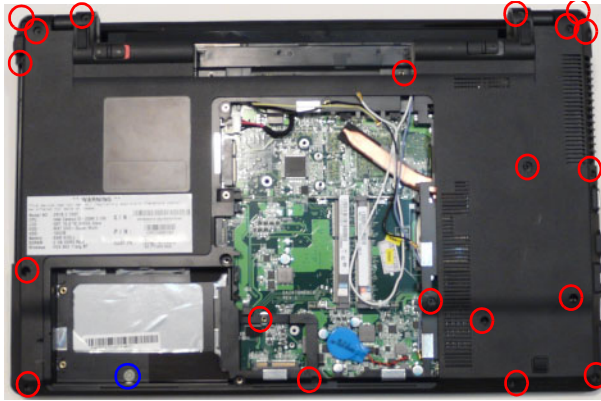

Step	Screw	Quantity	Screw Type
Upper Cover Disassembly	M2.5*4Ni (red call out)	6	
	M2*3 (blue call out)	3	

7. Turn the computer over and remove the twenty-one (21) screws in the lower cover.



Step	Screw	Quantity	Screw Type
Lower Cover Disassembly	M2.5*5 (red call out)	20	
	T2.5*2 Ni (blue call out)	1	

8. Turn the computer ninety degrees. Push the upper cover apart from the lower cover in the location shown.



9. Pry the upper cover away from the lower cover along the front edge.



10. Push the upper cover off the bottom cover.



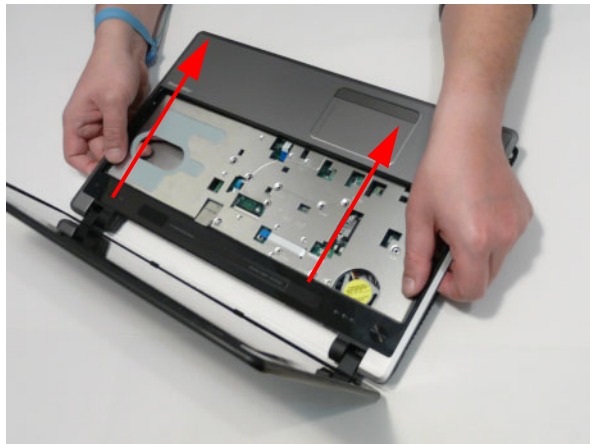

11. Lay the computer flat then pull the upper cover away from the lower cover.

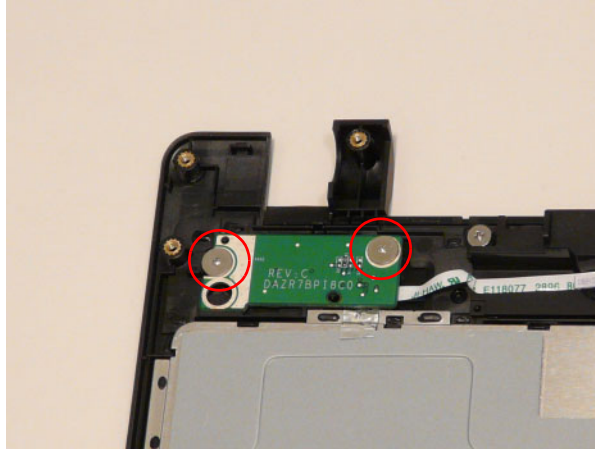

Removing the Switch Board

1. See "Removing the Upper Cover" on page 71.
2. Remove the two (2) screws.



Step	Screw	Quantity	Screw Type
Switch Board Disassembly	T2.5*2Ni	2	

3. Lift the switch board away from the upper cover and turn it over.

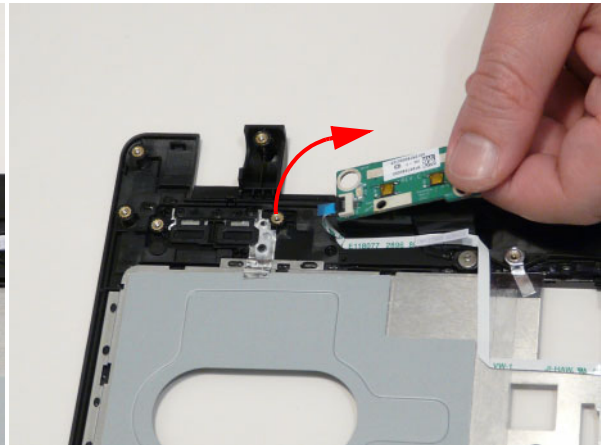
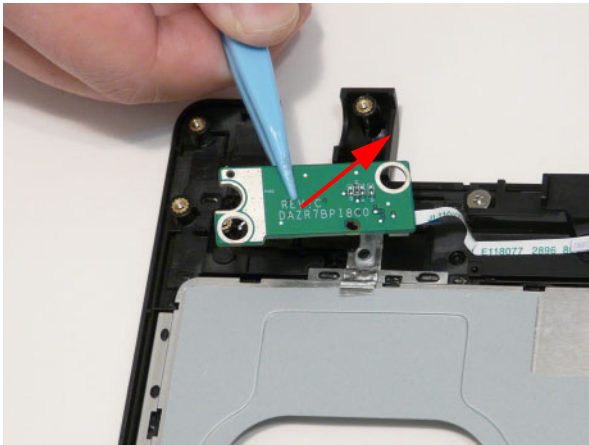

4. Unlock and disconnect the switch board FFC.

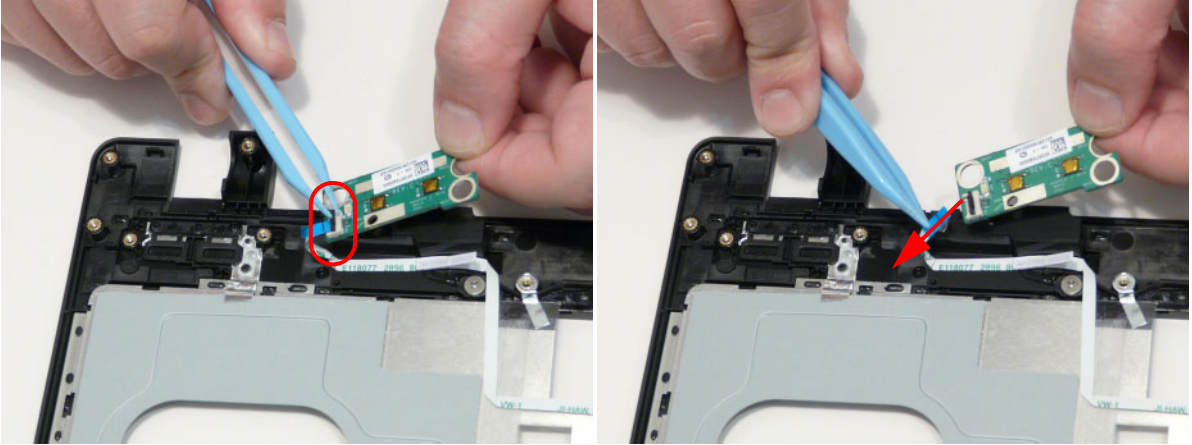

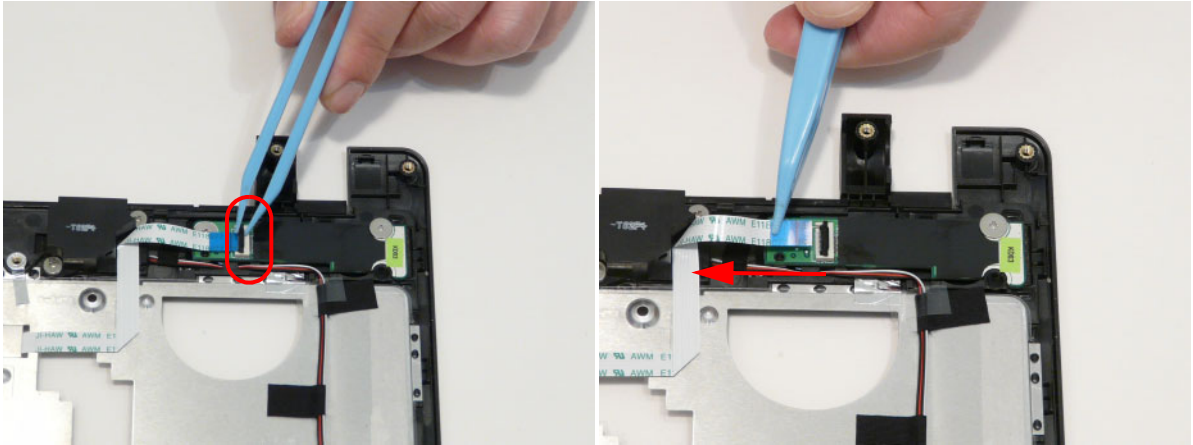

Removing the Power Board

1. See "Removing the Upper Cover" on page 71.
2. Unlock and disconnect the power board FFC.

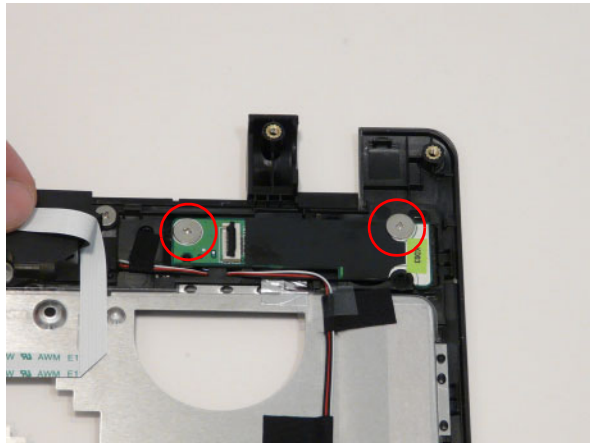

3. Remove the two (2) screws.



Step	Screw	Quantity	Screw Type
Power Board Disassembly	T2.5*2Ni	2	

-
4. Lift the power board away.

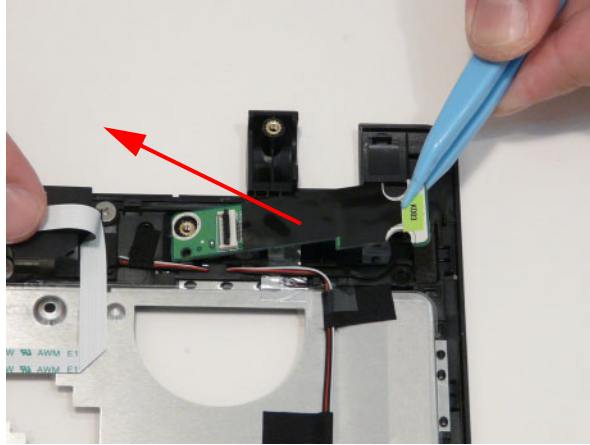

Removing the LCD Module

1. See “Removing the Upper Cover” on page 71.
2. Pull the LCD connector restraining tape off the mainboard.

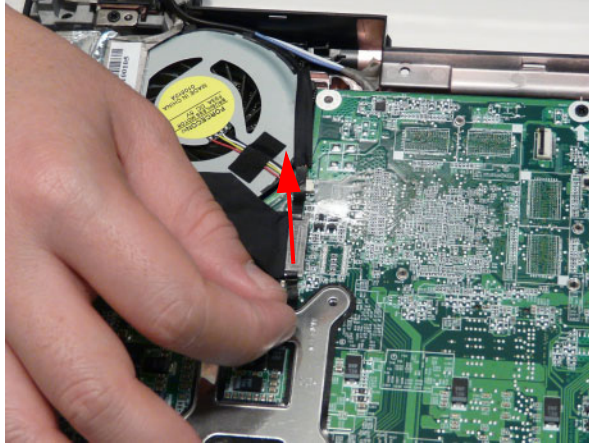

3. Disconnect the LCD connector.

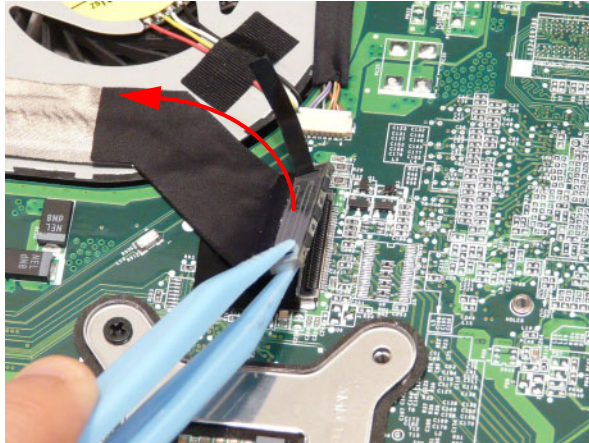

4. Pull the LCD cable off the assembly.

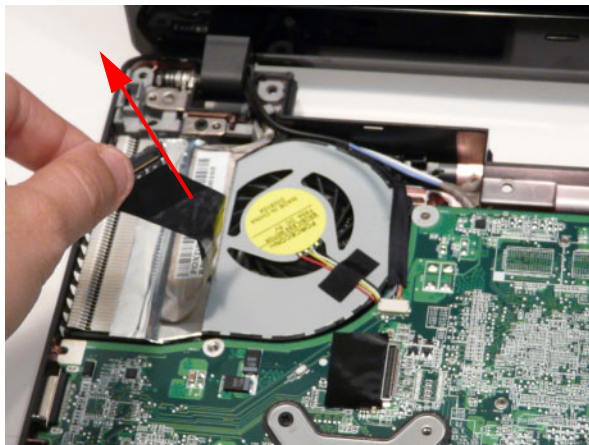

5. Disconnect the microphone connector.

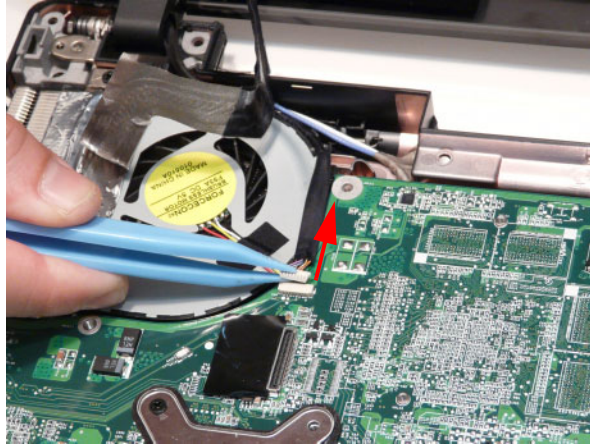

6. Pull the microphone cable off the assembly.

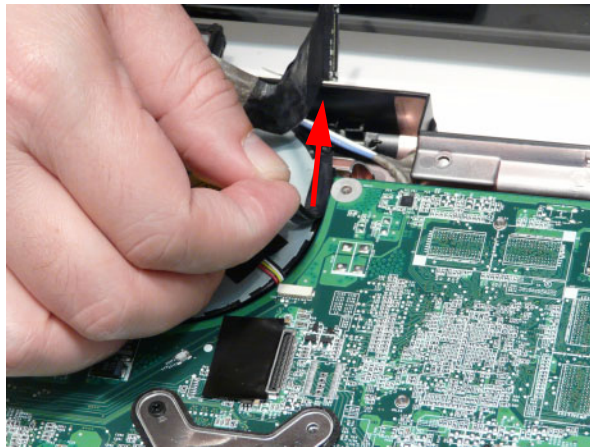

7. Turn the computer over and remove the antenna cables from the retention guides.



8. Remove the WLAN cables from the retention guides.

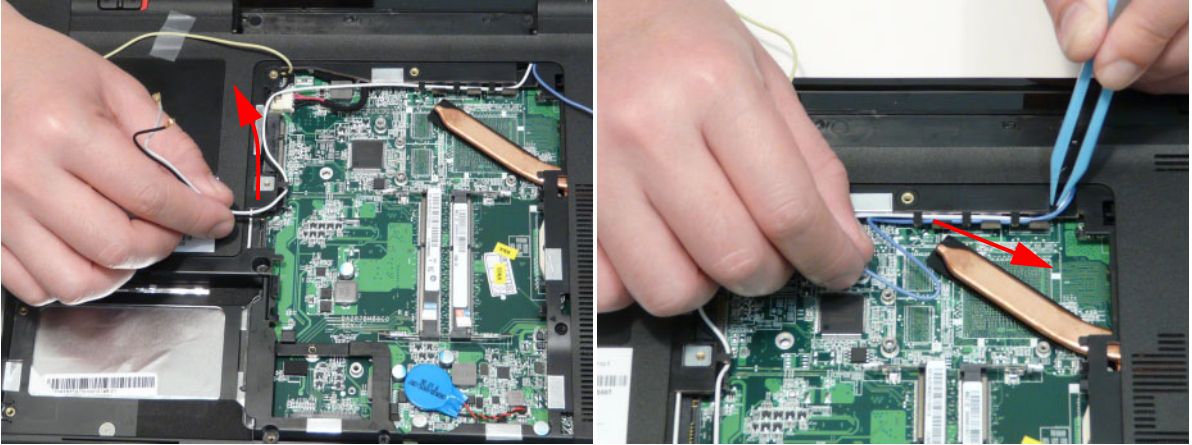

9. Turn the computer over and pull the adhesive tape along with the cable bundle off the bottom cover.

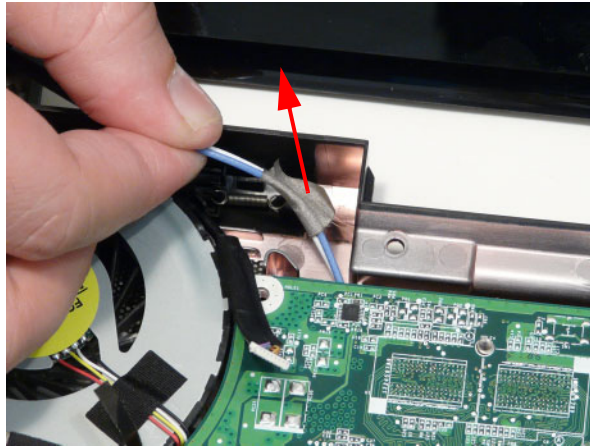

10. Pull the left antenna cables through and out of the assembly.

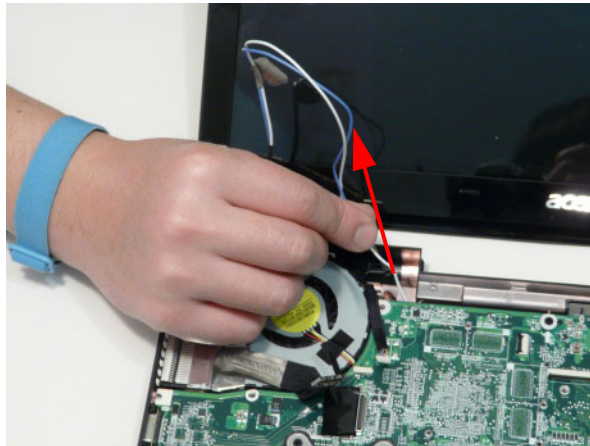

11. Remove the right antenna cables adhesive tape along with the cable bundle.

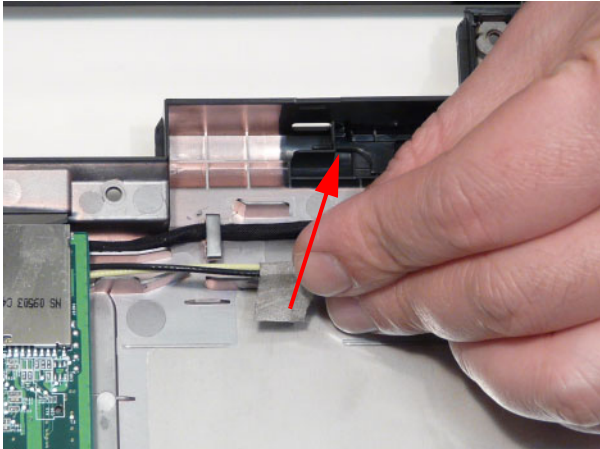

12. Remove the right antenna cables from the retention guide.

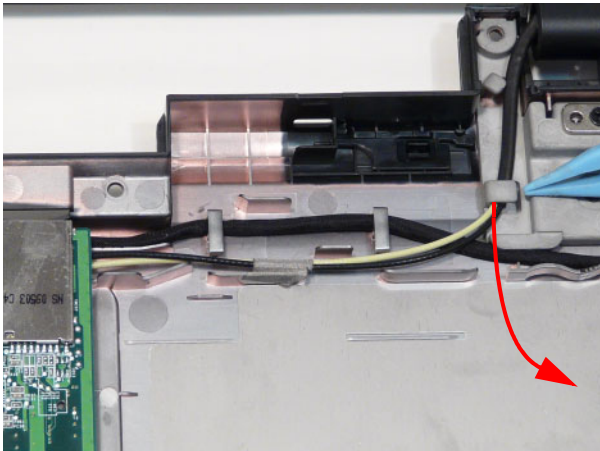

13. Remove the two (2) screws from the two hinges.

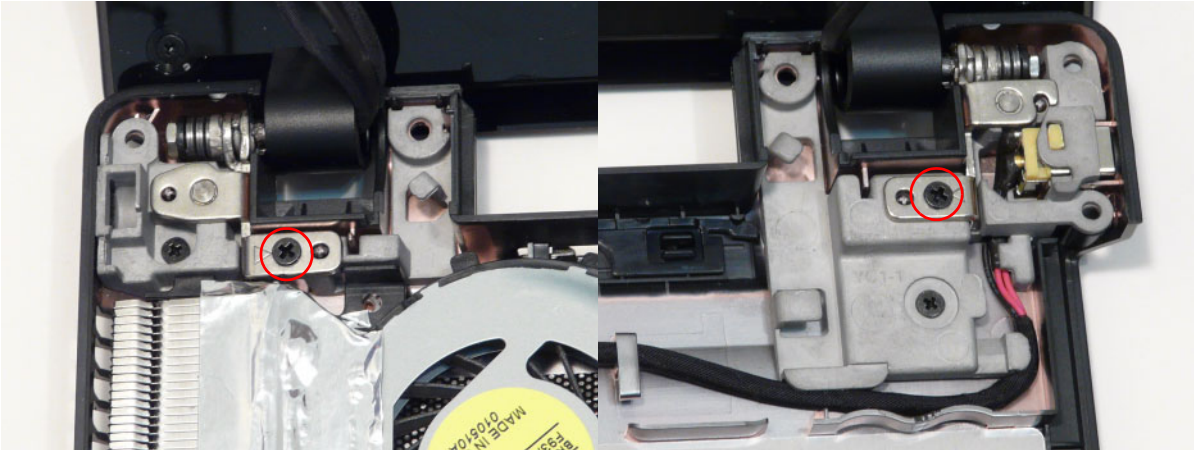

Step	Screw	Quantity	Screw Type
LCD Module Hinge Disassembly	M2.5*5	2	

14. Lift the LCD module out of the assembly.

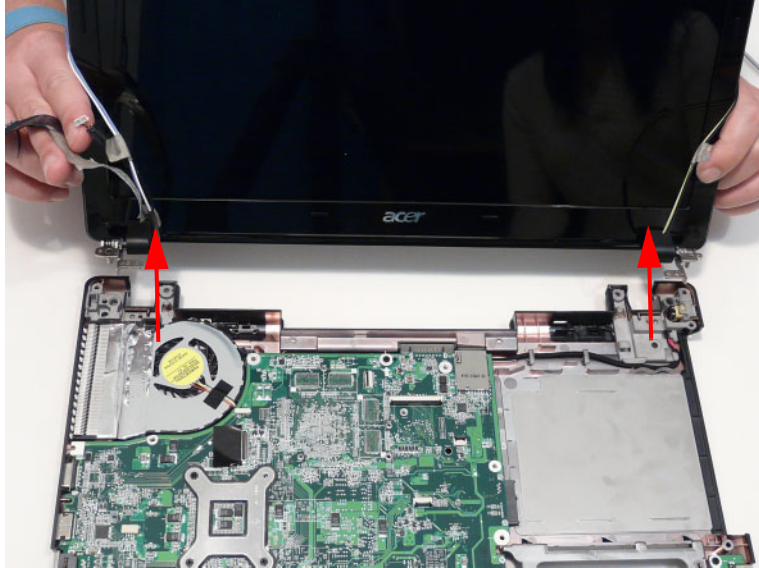

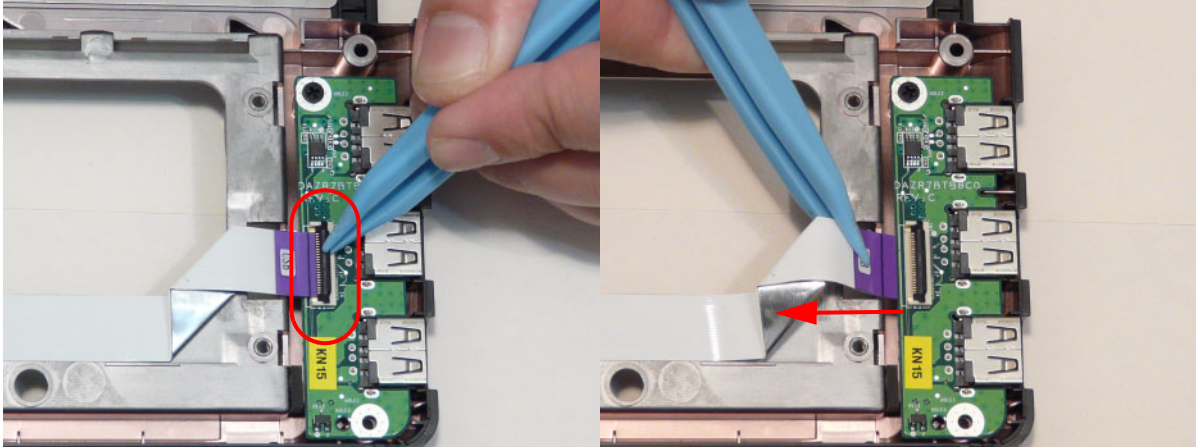

Removing the USB Board

1. See "Removing the Upper Cover" on page 71.
2. Unlock and remove the USB board FFC.

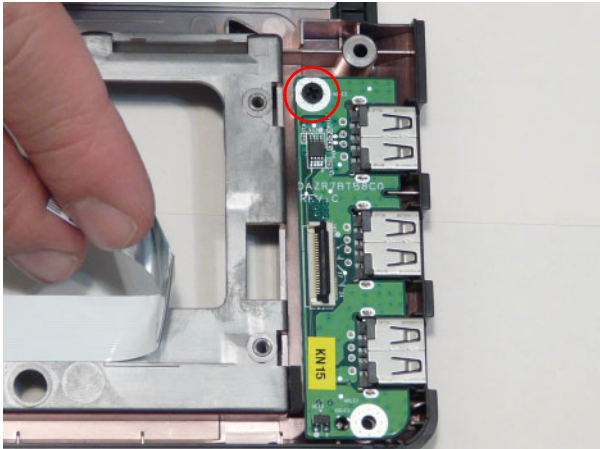

3. Remove the one (1) screw securing the USB Board to the Lower Cover.



Step	Screw	Quantity	Screw Type
USB Board Disassembly	M2.5*	1	

4. Lift away the USB board.

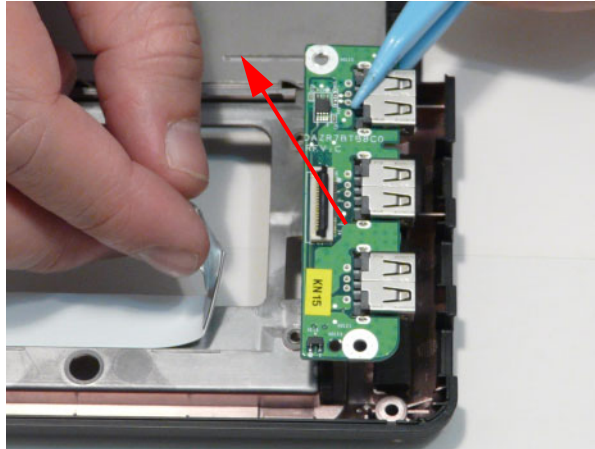

5. Unlock and remove the USB board FFC from the mainboard.

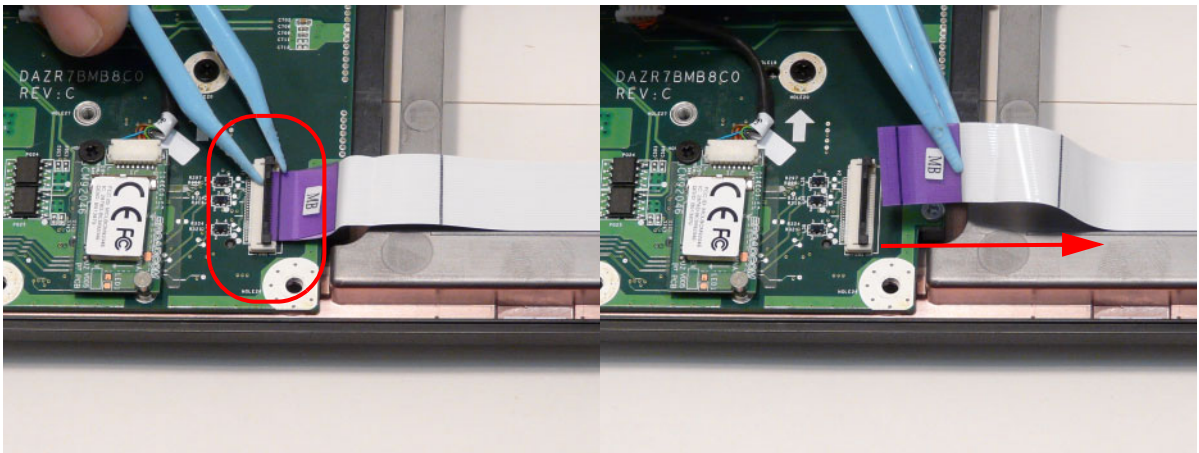

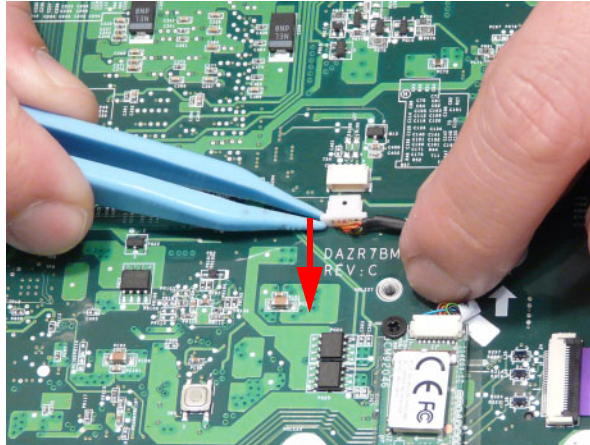

Removing the Bluetooth Module

1. See "Removing the Upper Cover" on page 71.
2. Detach the Bluetooth module cable from the mainboard.

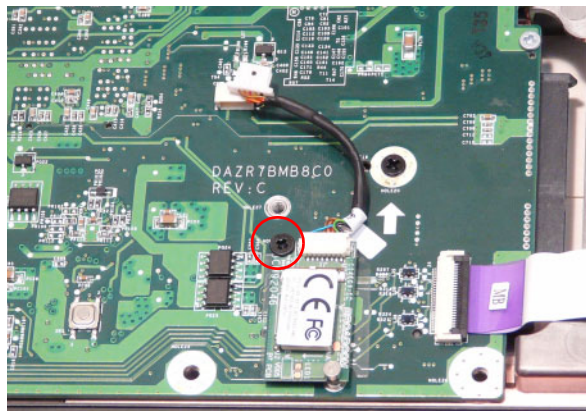

3. Remove the one (1) screw.



Step	Screw	Quantity	Screw Type.
Bluetooth Module Disassembly	M2.5*3	1	

-
4. Lift the Bluetooth module away from the computer.

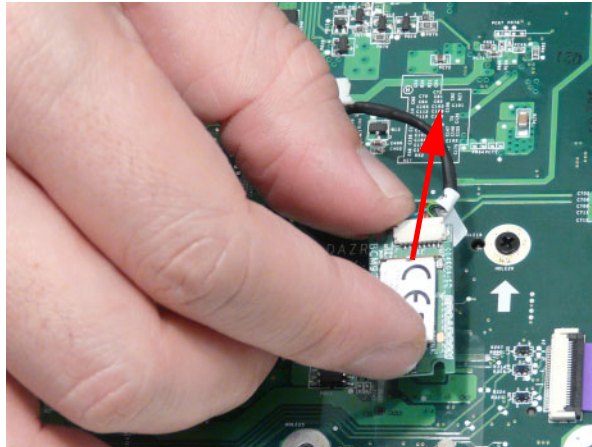

5. Detach the Bluetooth module cable from the module.

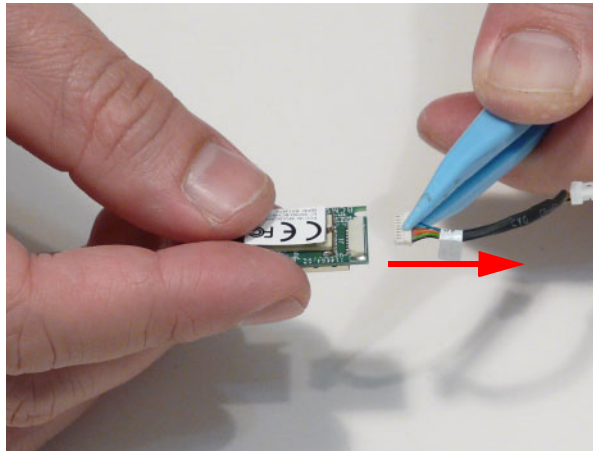

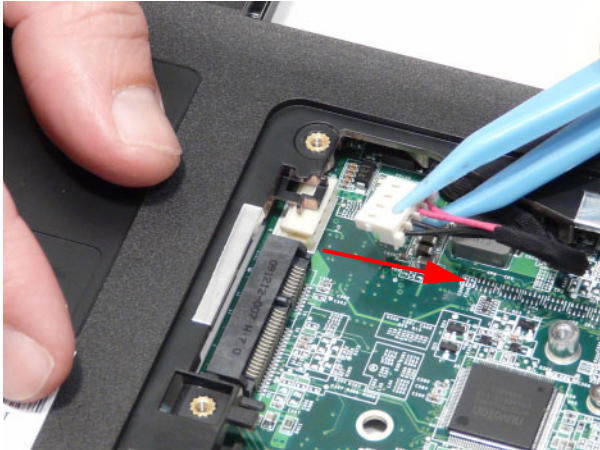

Removing the Mainboard

1. See "Removing the Upper Cover" on page 71.
2. See "Removing the USB Board" on page 84.
3. See "Removing the Bluetooth Module" on page 86.
4. Turn the computer over and disconnect the power cable from the mainboard.

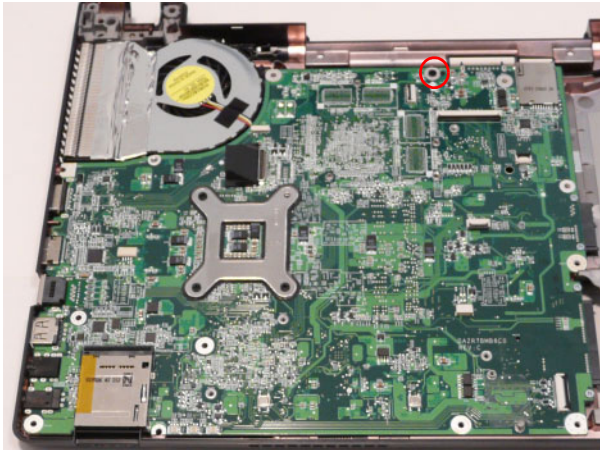

5. Turn the computer over and remove the one (1) screw of the mainboard.



Step	Screw	Quantity	Screw Type.
Mainboard Disassembly	M2.5*5	1	

-
6. Remove the main board out of the assembly: lift the internal edge up first then pull out the external connector edge.

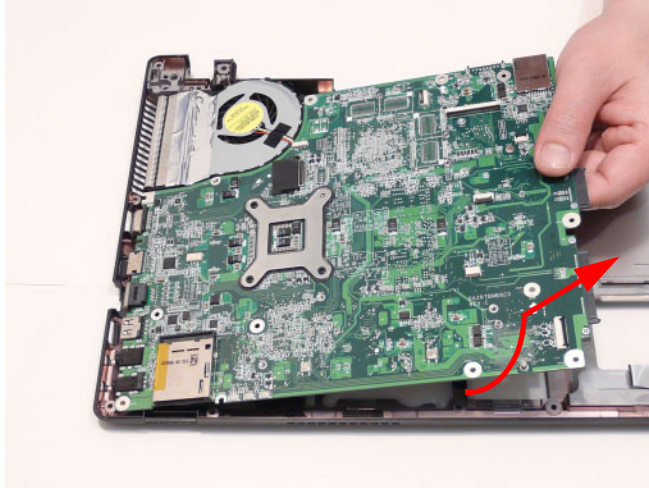

Removing the Thermal Module

1. See “Removing the Mainboard” on page 88.
2. Disconnect the thermal module fan connector.

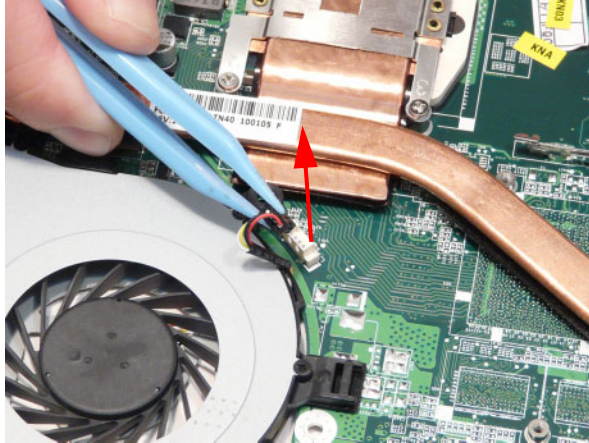

3. Loosen the four (4) captive screws in order: 4, 3, 2, and last 1.

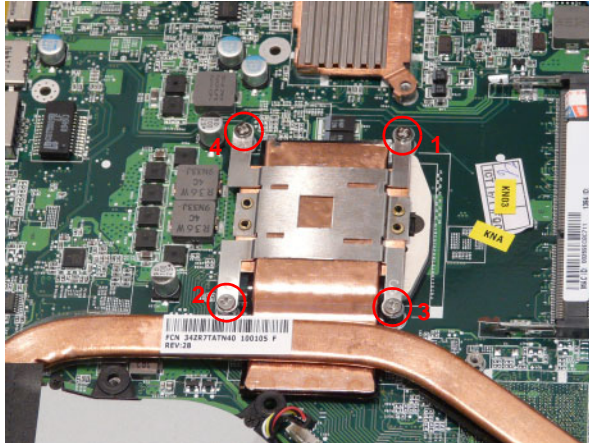

4. Lift the thermal module away from the main board.

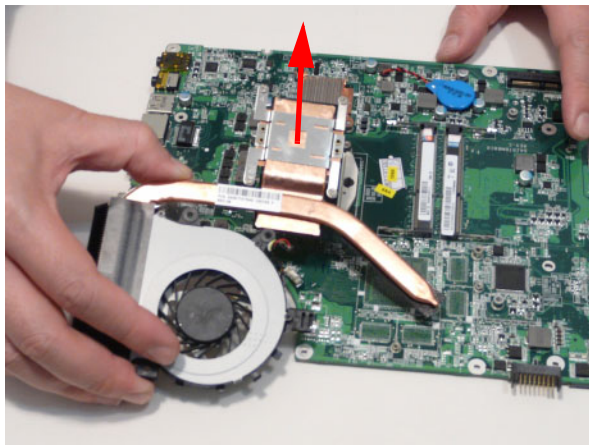

Removing the CPU

1. See “Removing the Mainboard” on page 88.
2. See “Removing the Thermal Module” on page 90.
3. Unlock the CPU. Use a flat head screw driver to turn the screw 180° counter clockwise.

NOTE: The location of the locking lug on the CPU screw.

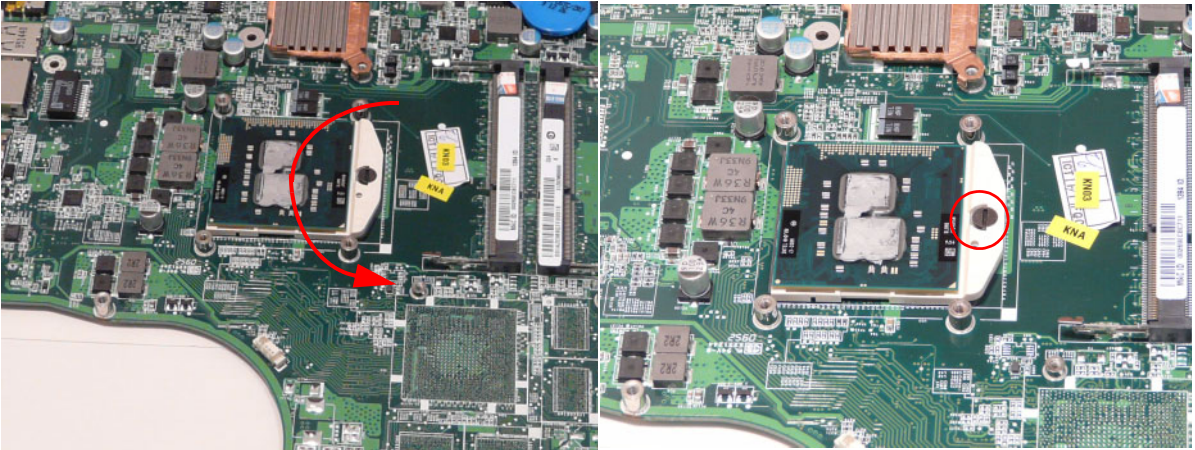

4. Lift the CPU out of the socket.

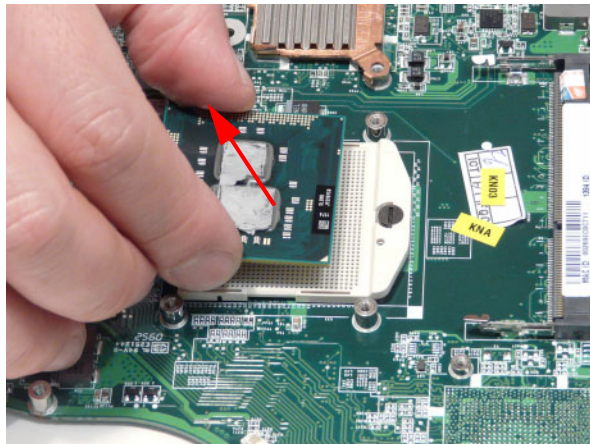

Removing the PCH Thermal Unit

1. See “Removing the Mainboard” on page 88.
2. See “Removing the Thermal Module” on page 90.
3. Loosen the one (1) captive screw.

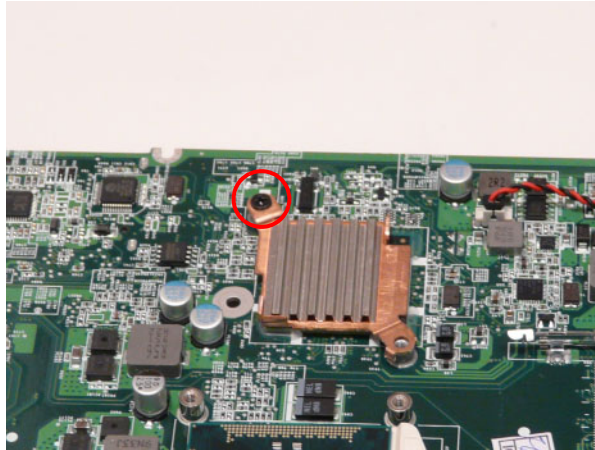

4. Lift the thermal unit away.

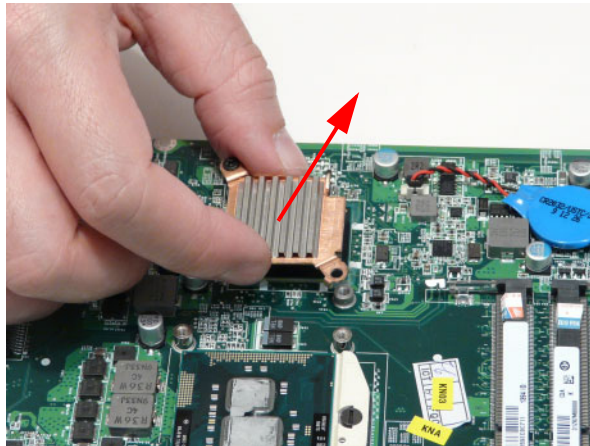

 **NOTE:** Circuit boards >10 cm² have been highlighted with a yellow rectangle as shown in the previous image. Please detach the circuit board and follow local regulations for disposal.

Removing the Power Cable Assembly

1. See "Removing the Mainboard" on page 88.
2. Remove the power cable from the retention guides.

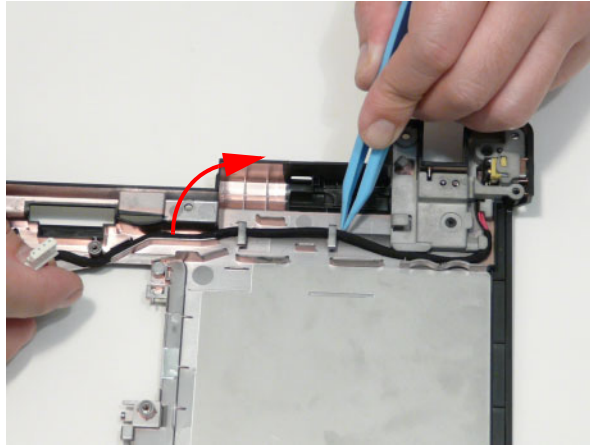

3. Remove the one (1) screw from the power assembly bracket.

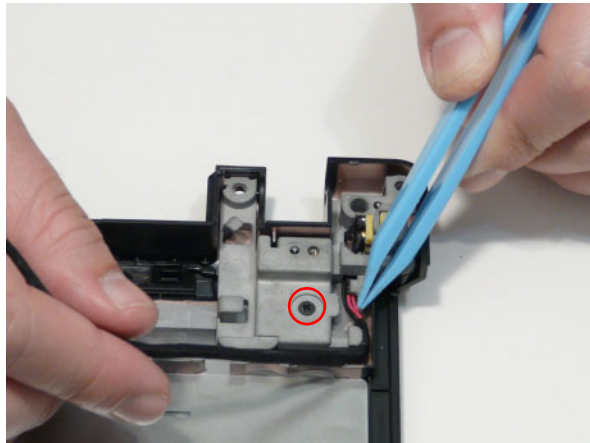

Step	Screw	Quantity	Screw Type
Power Assembly Disassembly	M2.5*4	1	

-
4. Lift the power cable assembly out of the chassis.

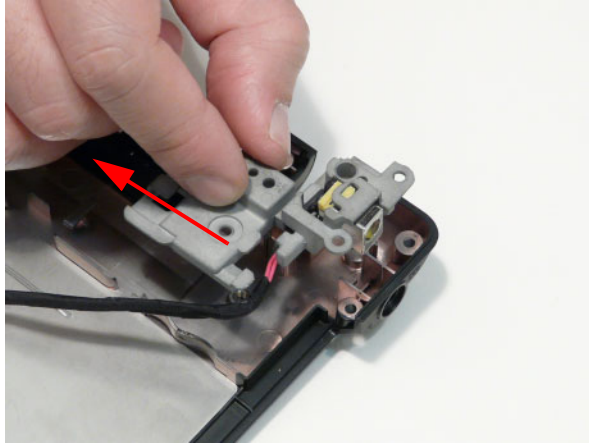

5. Lift the power cable connector out of the bracket.

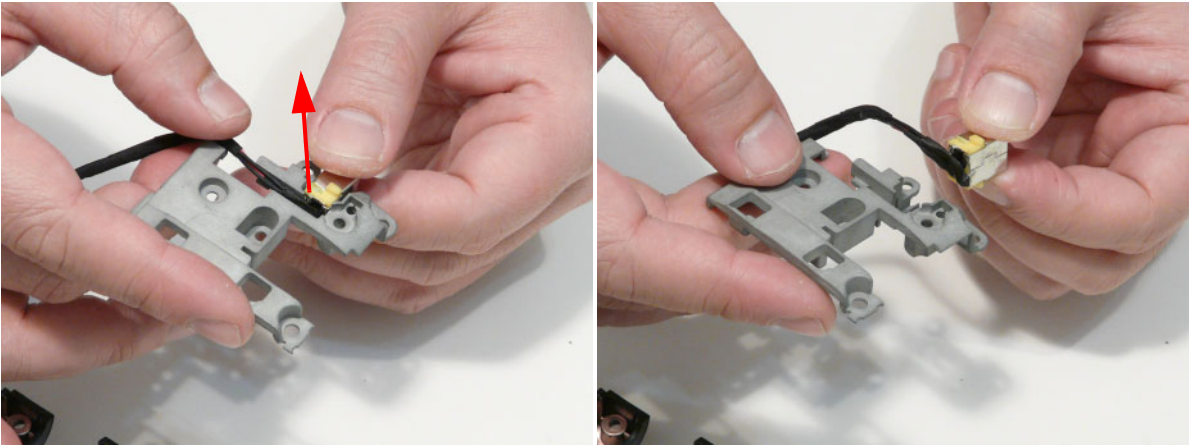

LCD Module Disassembly Process

IMPORTANT: Cable paths and positioning may not represent the actual model. During the removal and replacement of components, ensure all available cable channels and clips are used and that the cables are replaced in the same position.

NOTE: The product previews seen in the disassembly procedures may not represent the final product color or configuration.

LCD Module Disassembly Flowchart

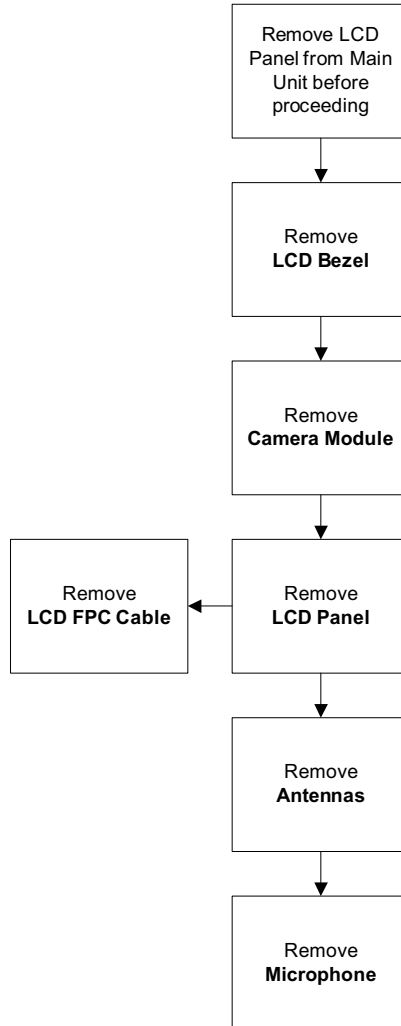

Screw List

Step	Screw	Quantity	Part No.
LCD Bezel Disassembly	M2.5*4	2	86.PTN07.004
LCD Panel Disassembly	M2.5*3	4	86.A08V7.005
Left Hinge Disassembly	M2.5*3	2	86.PTN07.003
Right Hinge Disassembly	M2.5*3	2	86.PTN07.003

Removing the LCD Bezel

- 1. See "Removing the Switch Board" on page 75.
- 2. Remove the two (2) bezel screw covers and screws.



Step	Screw	Quantity	Screw Type
LCD Bezel Disassembly	M2.5*4	2	

- 3. Pry the bezel away from the top and then work around one corner.

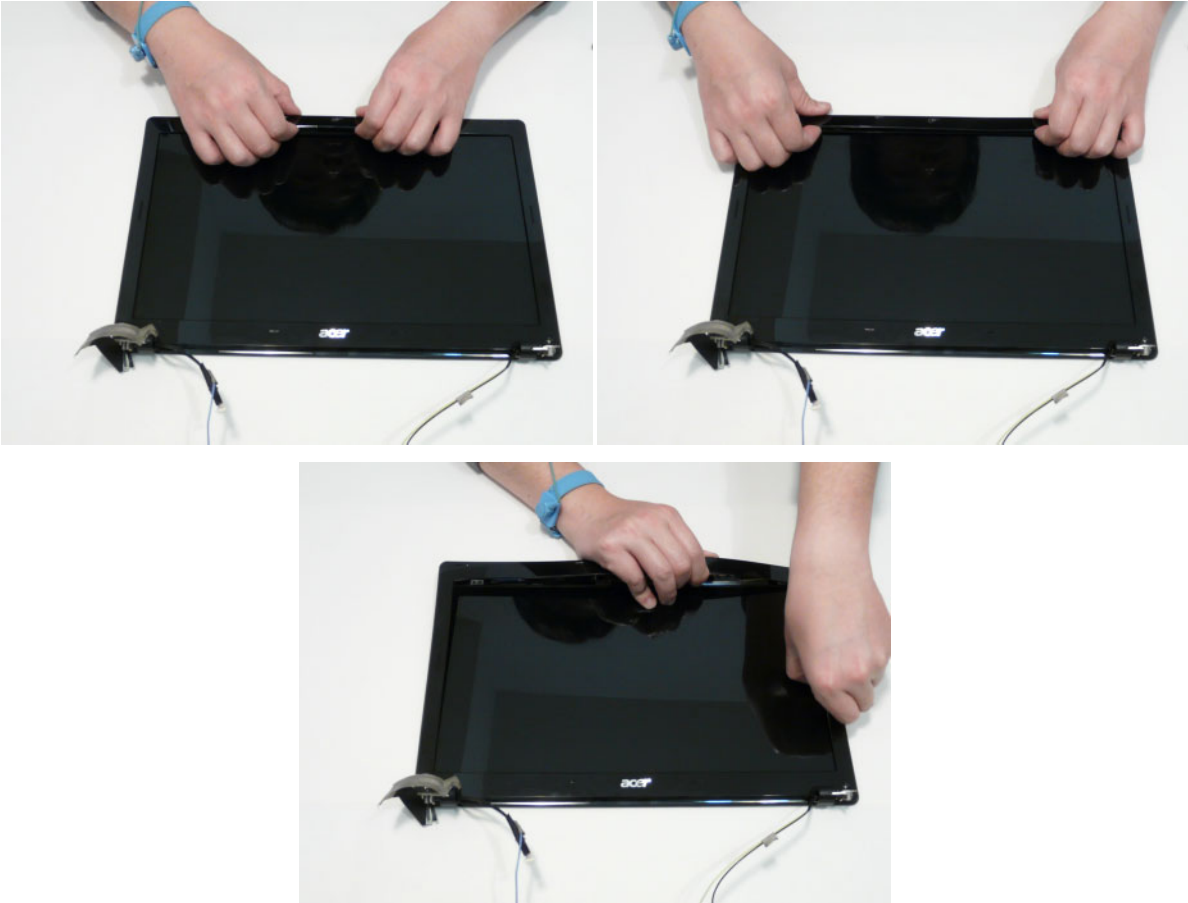

-
4. Pry open the bottom corners and along the bottom edge.

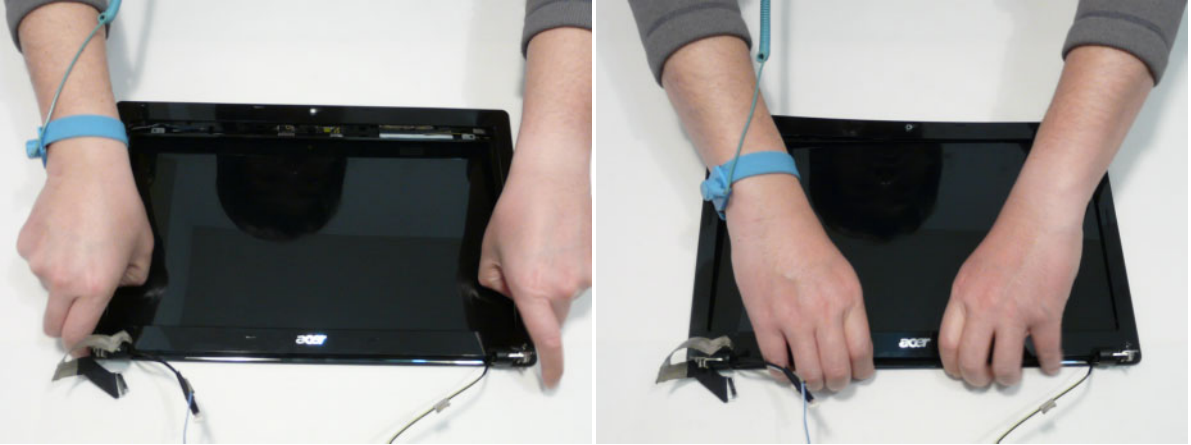

5. Lift the bezel off the module.



Removing the Camera Board

1. See "Removing the LCD Bezel" on page 96.
2. Disconnect the camera connector.



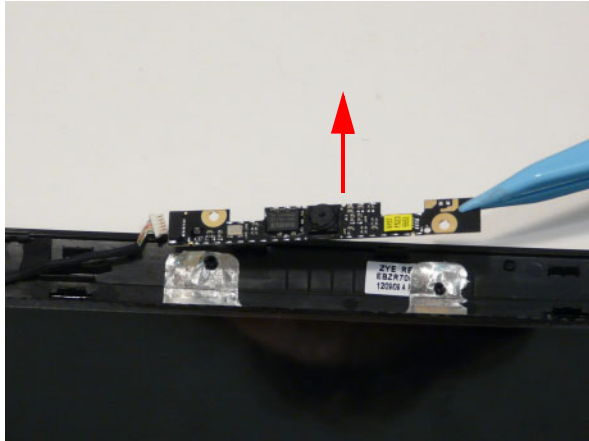

3. Pull up the camera board.

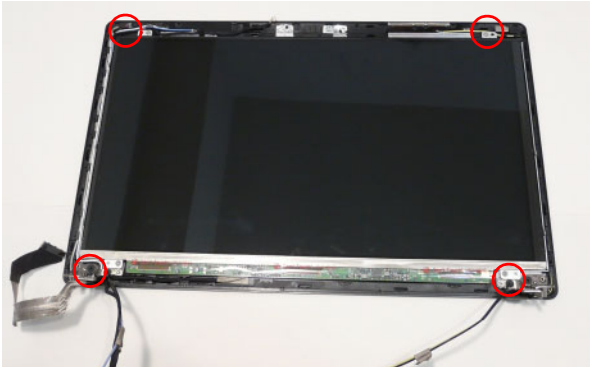

Removing the LCD Panel

1. See "Removing the Camera Board" on page 98.
2. Remove the four (4) screws of the LCD panel.



Step	Screw	Quantity	Screw Type
LCD Panel Disassembly	M2.5x3	4	

3. Remove the two (2) screws in the left hinge.



Step	Screw	Quantity	Screw Type
Remove Left Hinge	M2.5x3	2	

4. Lift the left hinge off the module.

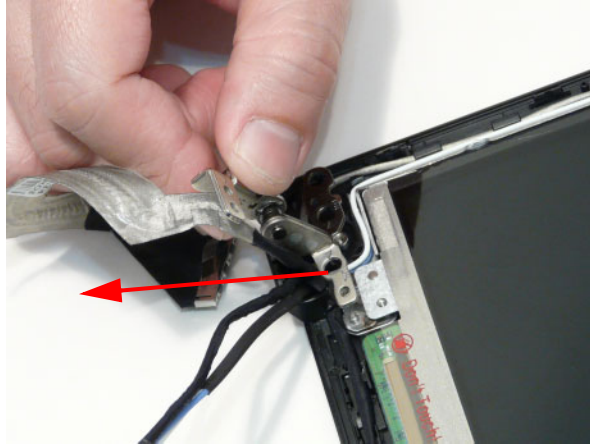

5. Lift the LCD panel out.

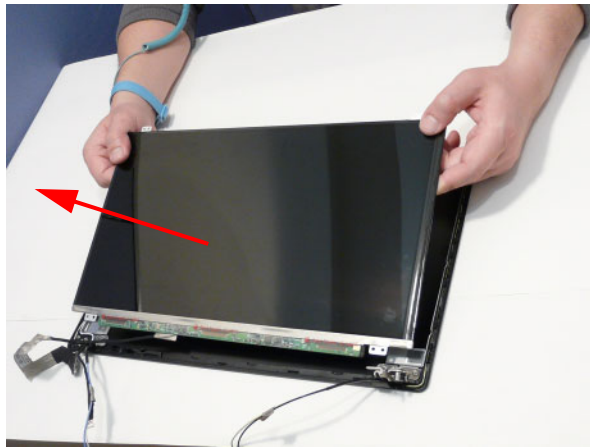

6. Lift the LCD panel out, turn over and remove the protective tape over the FPC cable connector.

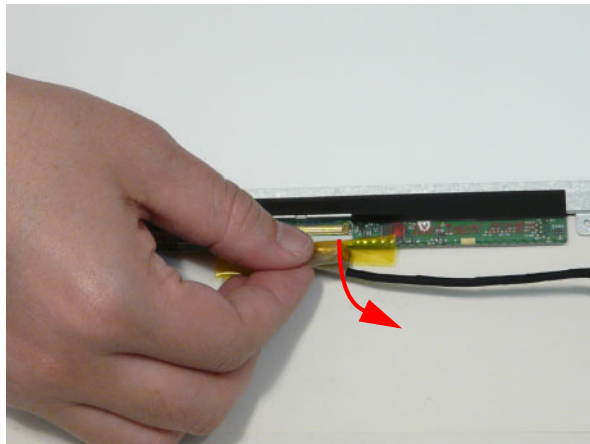

7. Disconnect the FPC cable.

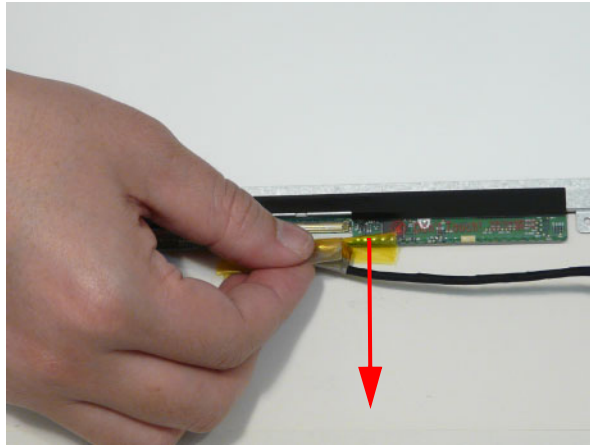

Removing the Antennas

1. See "Removing the LCD Panel" on page 99.
2. Remove the cables from the retention guides.

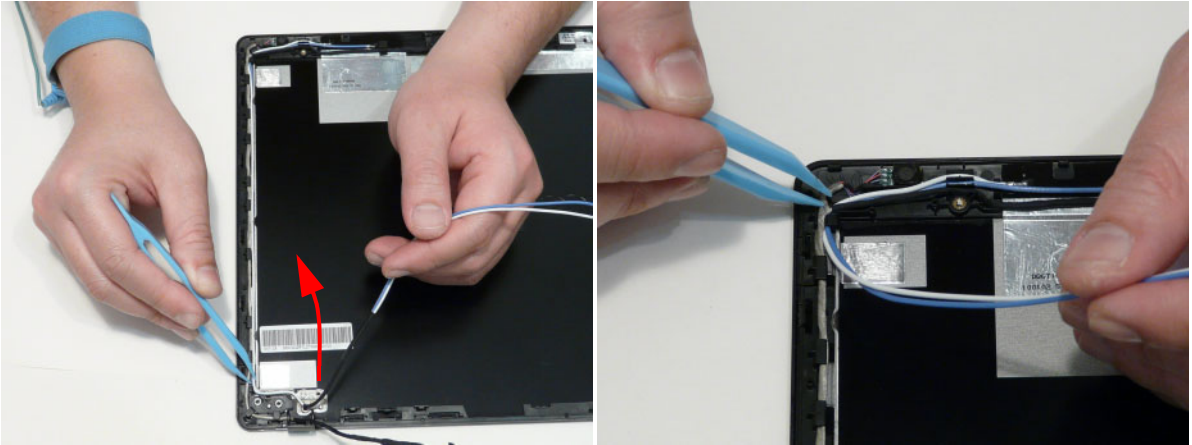

3. Free the cables completely.

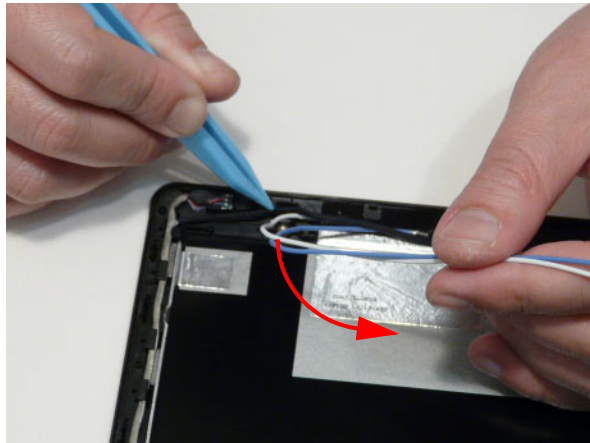

4. Pull up the camera cable adhesive tape.

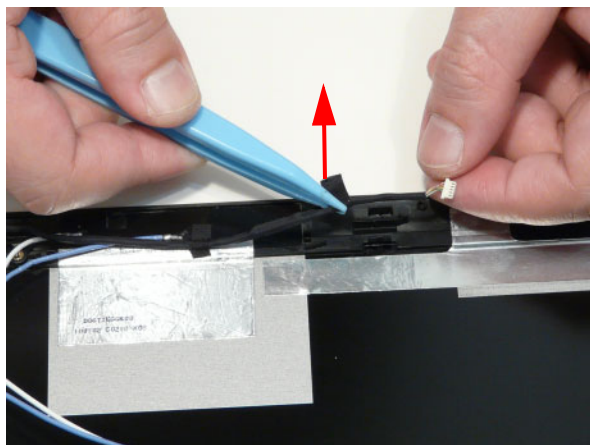

5. Pry the antenna off the casing.

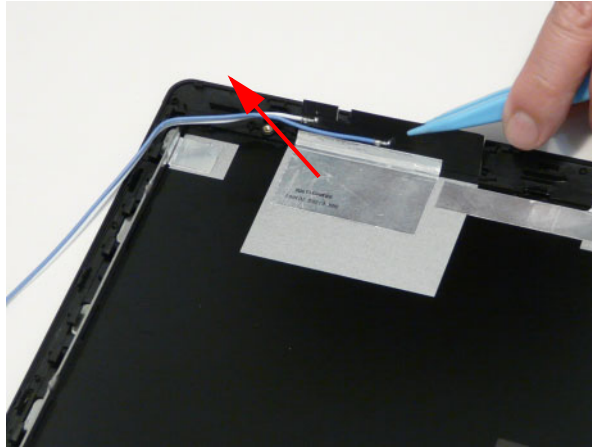

6. Remove the two (2) screws of the right hinge.



Step	Screw	Quantity	Screw Type
Right Hinge Disassembly	M2.5*3	2	

7. Lift away the hinge.

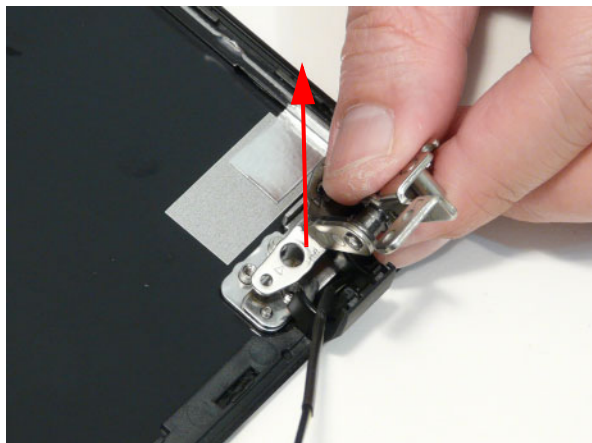

-
8. Remove the cables from the retention guides.

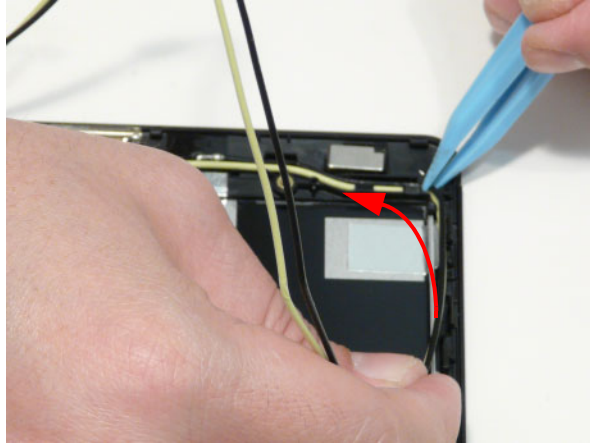

9. Pry the antenna off the casing.

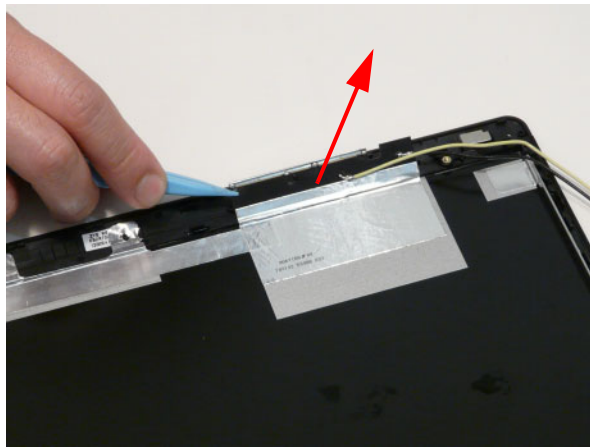

Removing the Microphone Cable

1. See "Removing the Antennas" on page 102.
2. Pry the microphone up.

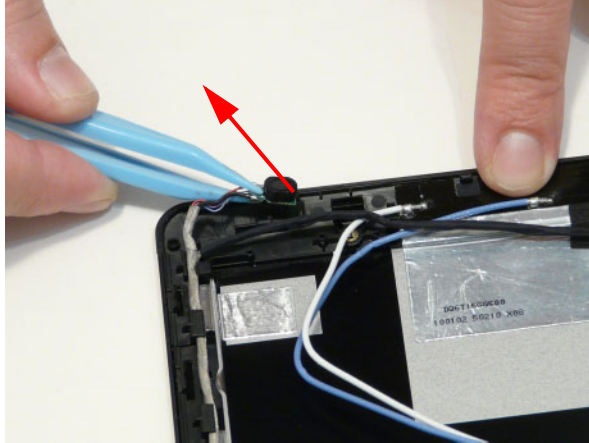

3. Lift the microphone cable out of the retention guides.

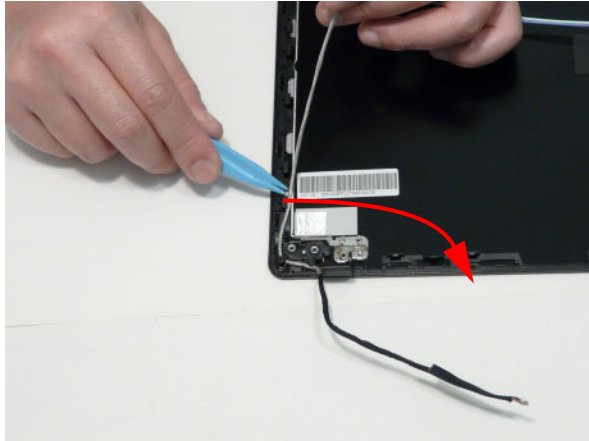

LCD Reassembly Procedure

NOTE: Adhesive is required to be added at various steps to cables and components. Locations of adhesive to be added is designated with a: ●

NOTE: During manufacture a cyanoacrylate glue is used provided by Holdtite Adhesives LTD. This is not a specified requirement. The reassembler is free to select an alternative appropriate adhesive.

Replacing the Microphone

1. Lay the microphone cable in the retention guides.

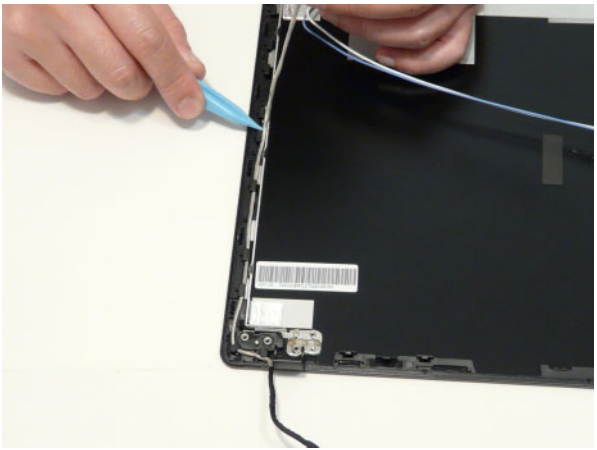
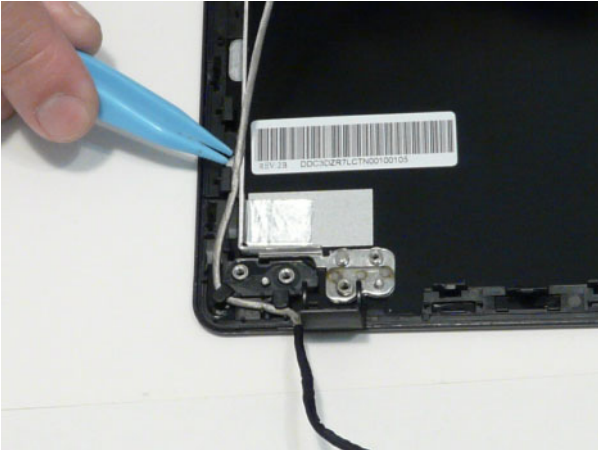

2. Replace and adhere the microphone.

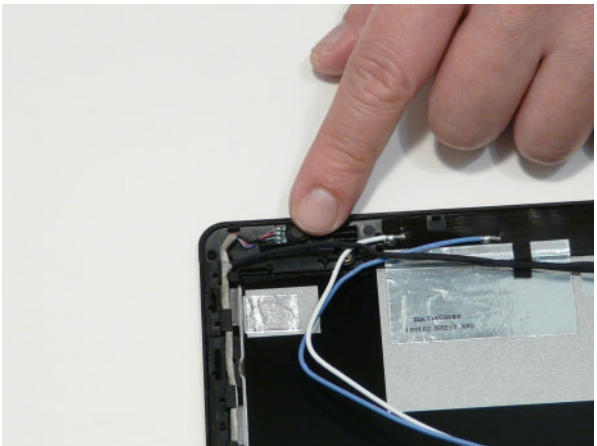
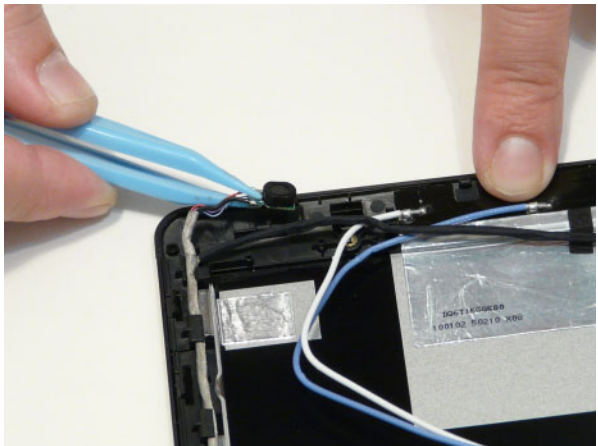

Replacing the Antennas

1. See See “Replacing the Microphone” on page 106.
2. Adhere the antenna down firmly onto the LCD module casing.

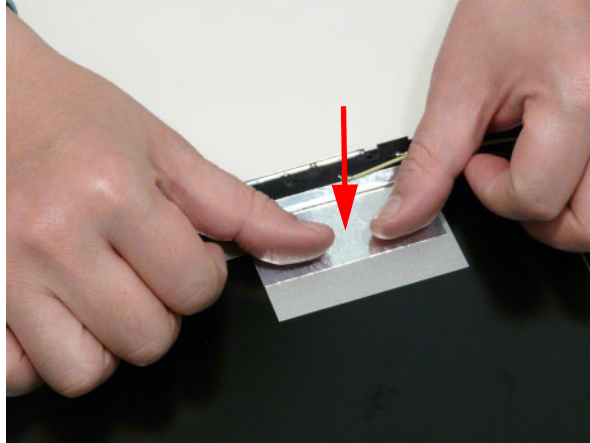

3. Lay the cables around the module edge for the right antenna.

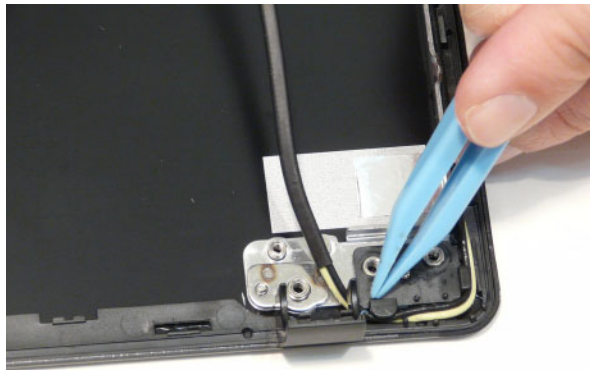
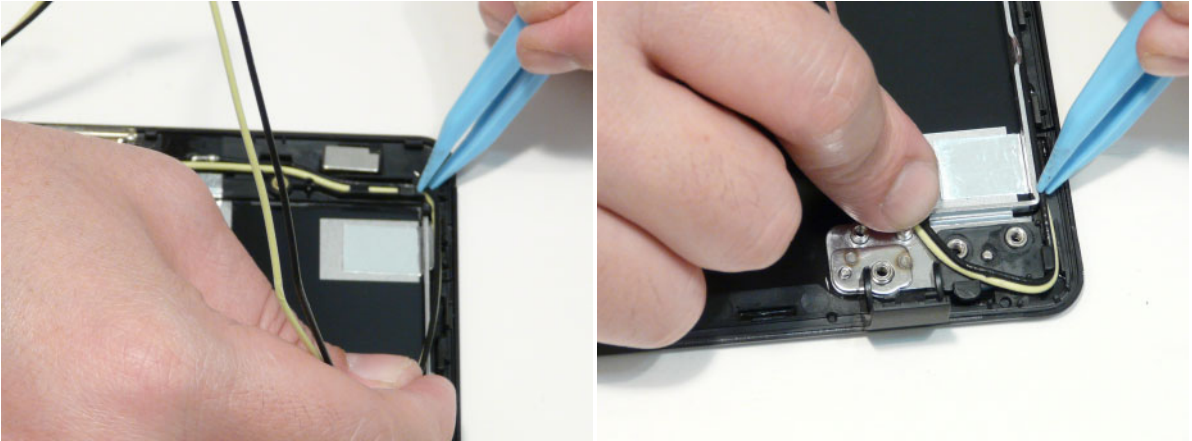

4. Replace the right hinge.

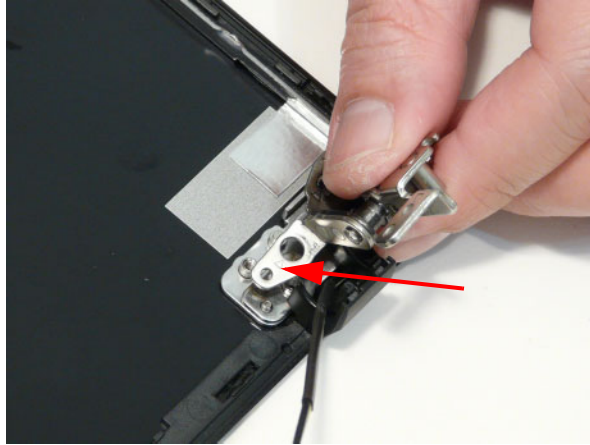

Step	Screw	Quantity	Screw Type
Replace Right Hinge	M2.5*3	2	

5. Replace the two (2) screws. Ensure that the cable is coming out of the hinge correctly.



6. Adhere the left antenna to the casing, pressing firmly down on the foil and antenna.

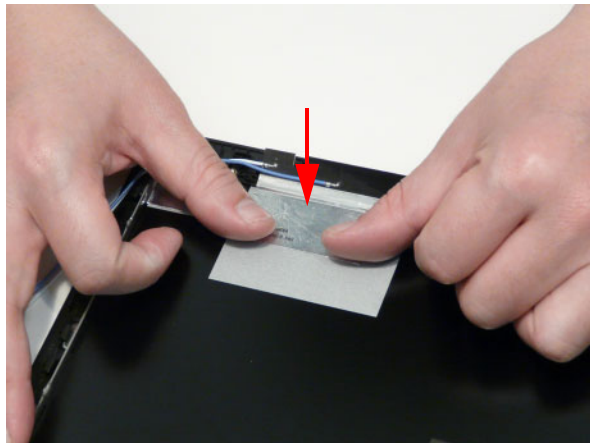

7. Lay the cables along the retention guides.

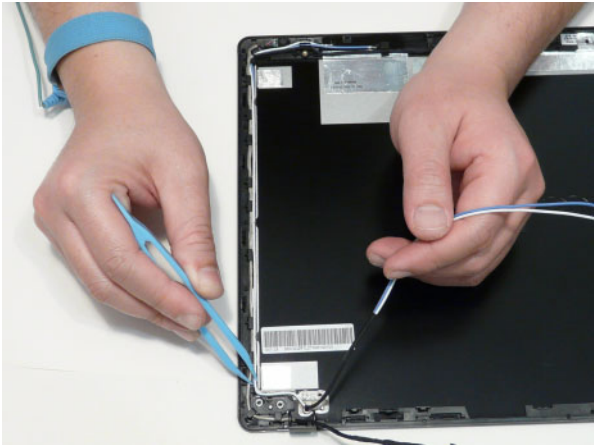
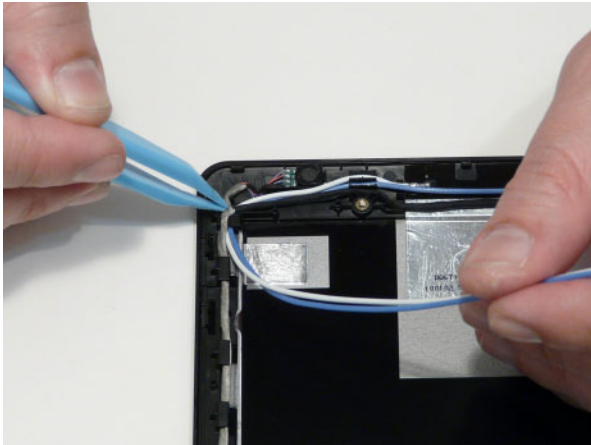

Replacing the LCD FPC Cable

1. Connect the FPC cable connector.

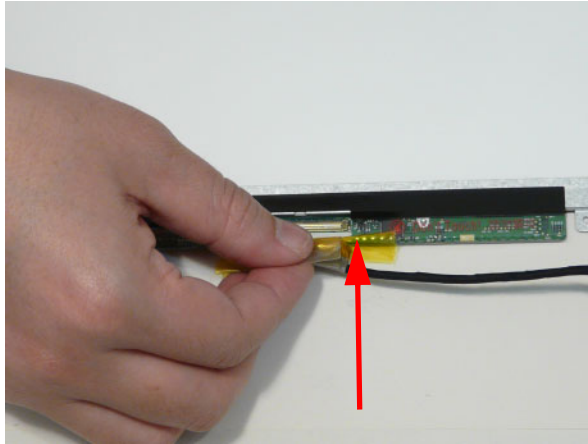

2. Place the protective clear adhesive mylar tape down firmly over the connector.

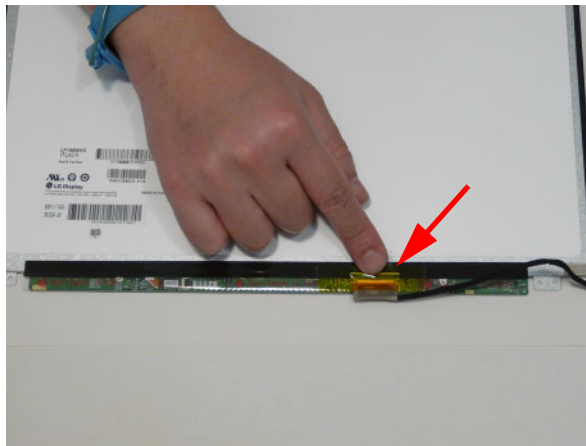

Replacing the LCD Panel

1. Place the LCD panel into LCD module as shown bottom edge first, making sure the cable is not trapped behind the panel.

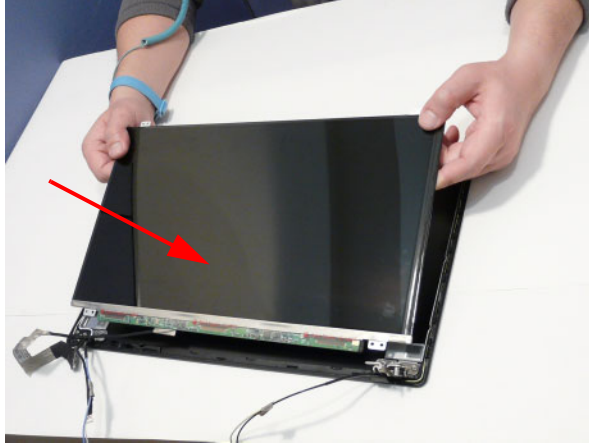

2. Place the left hinge onto the LCD module.

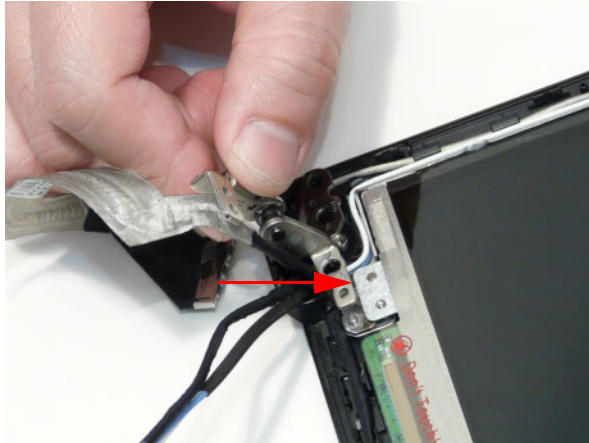

3. Replace the two (2) screws, while ensuring the cables pass through the hinge correctly.



Step	Screw	Quantity	Screw Type
Replace Left Hinge	M2.5*3	2	

Replacing the Camera Board

1. Replace the camera cable and adhere the tapes.

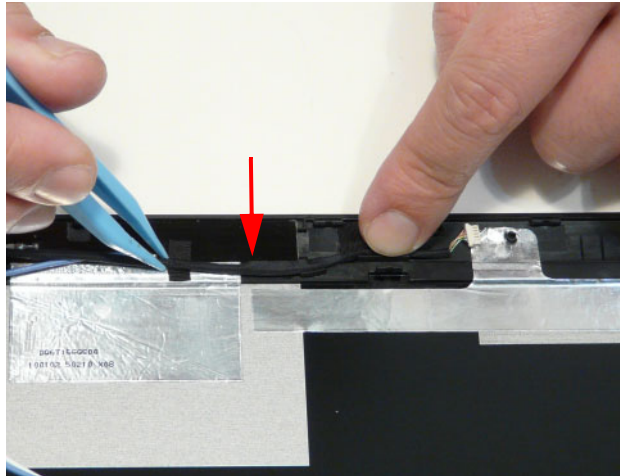

2. Apply adhesive and lay the Camera Board board down pressing firmly.

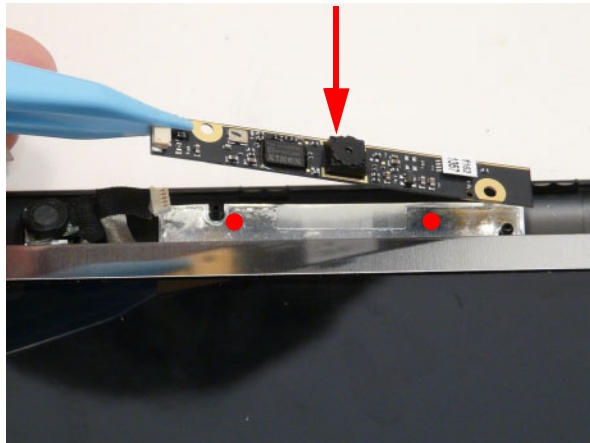

3. Connect the cable to the Camera Board.

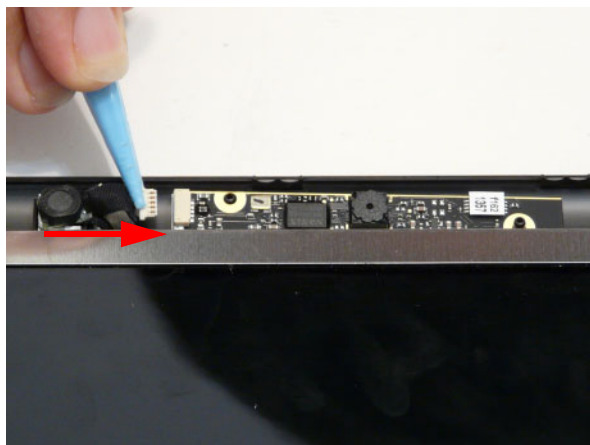

Replacing the LCD Bezel

1. Place the bezel hinge covers over the hinges.



2. Press down on the top middle edge of the bezel to engage the locking clips.



3. Press down on the bezel edge working simultaneously around the edges to the bottom.

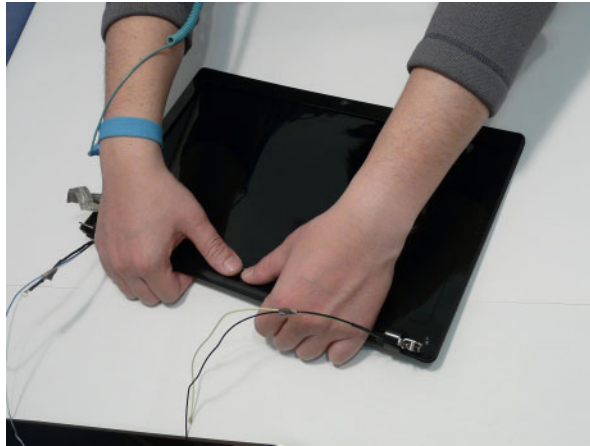
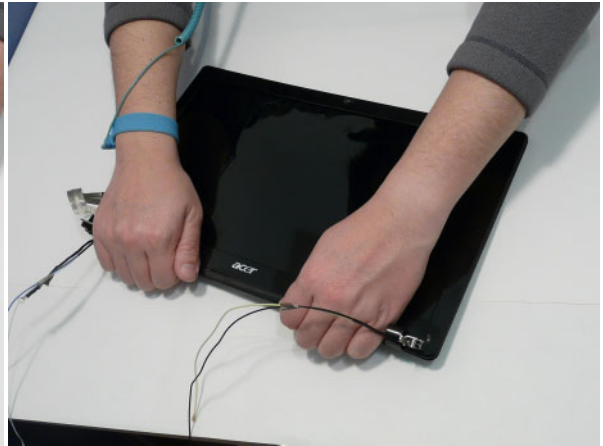

4. Replace the two (2) bezel screws and screw covers.



Step	Screw	Quantity	Screw Type
Replace LCD Bezel	M2.5*4	2	

Main Unit Reassembly Process

Replacing the Power Assembly

1. Place the power jack into the bracket.

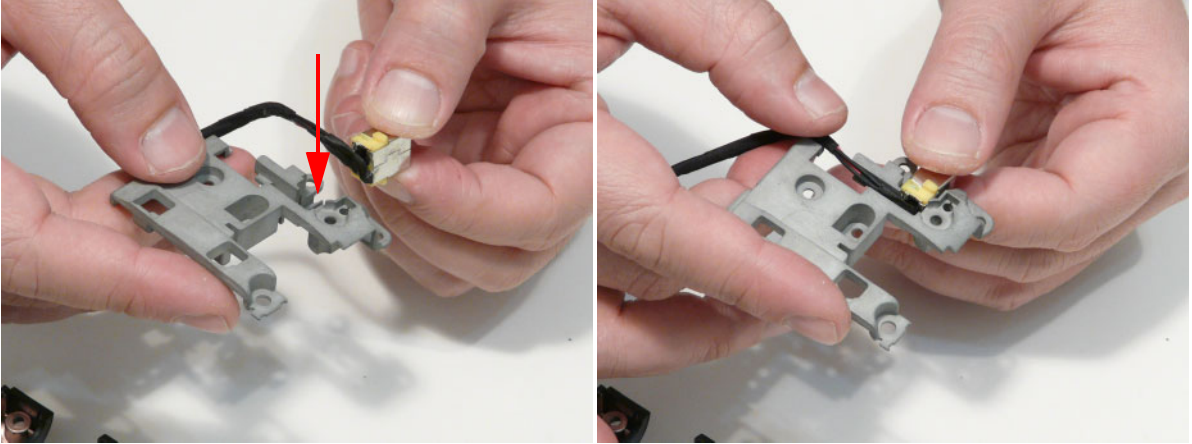

2. Place the bracket into the lower cover.

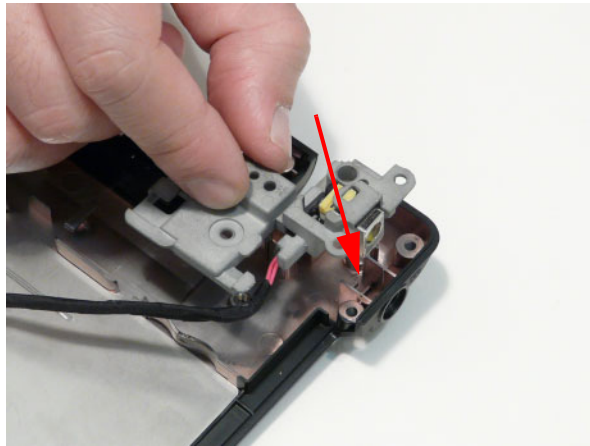

3. Replace the one (1) screw.

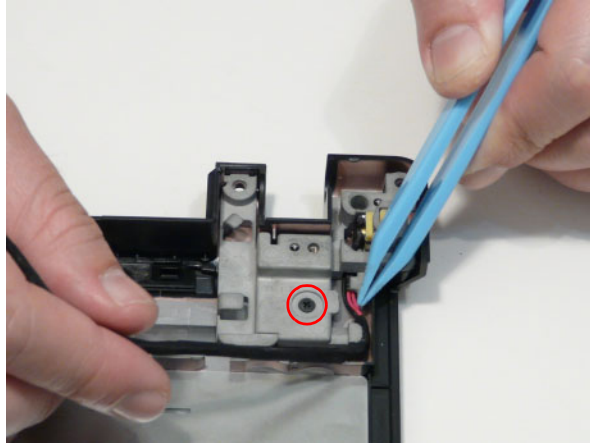

Step	Screw	Quantity	Screw Type
Replace Power Assembly	M2.5*4	1	

4. Lay the cables in the retention guides.

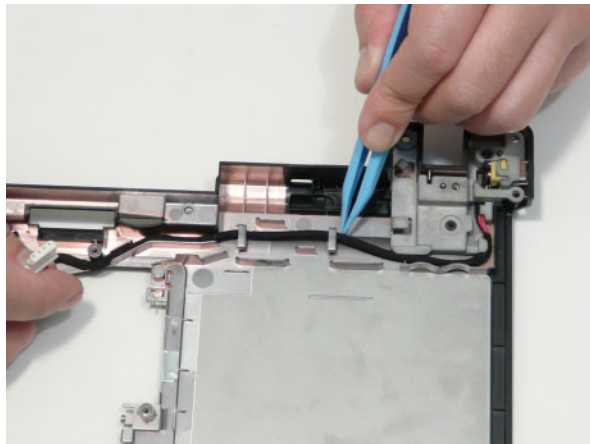

Replacing the PCH Thermal Module

1. Place the PCH thermal module on the chip.

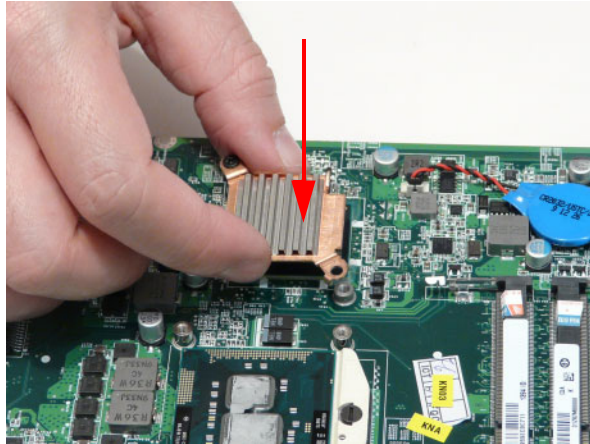

2. Tighten the one (1) captive screw.

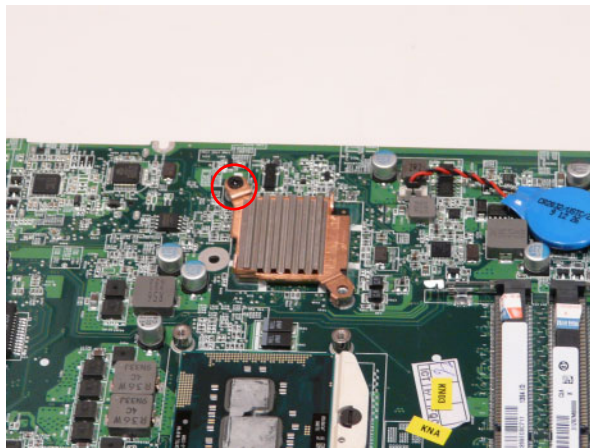

Replacing the CPU

IMPORTANT: The mainboard has a Pin1 locator that must be positioned corresponding to the marker on the CPU.

1. Place the CPU into the CPU socket as shown, taking note of the Pin1 locator.

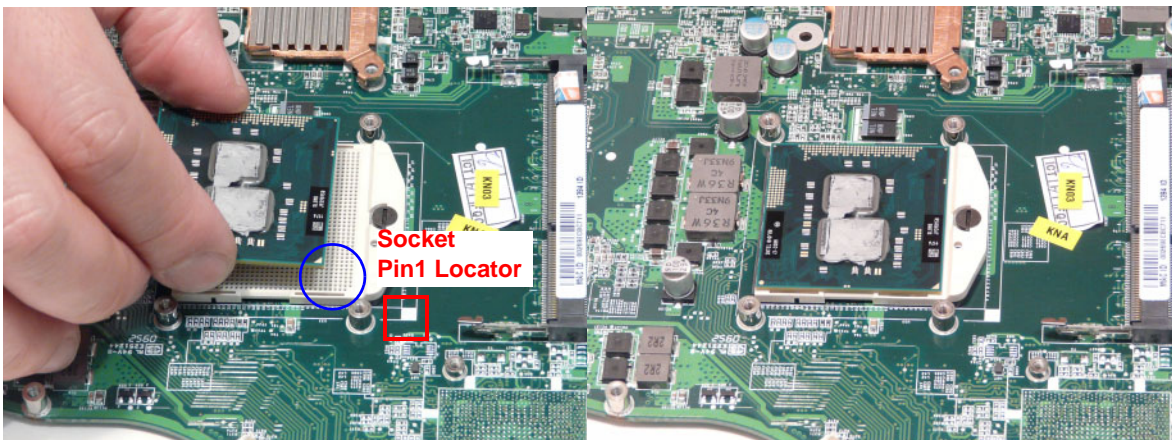

-
- Using a flat-bladed screw driver, rotate the CPU locking screw 180° clockwise to secure the CPU in place.

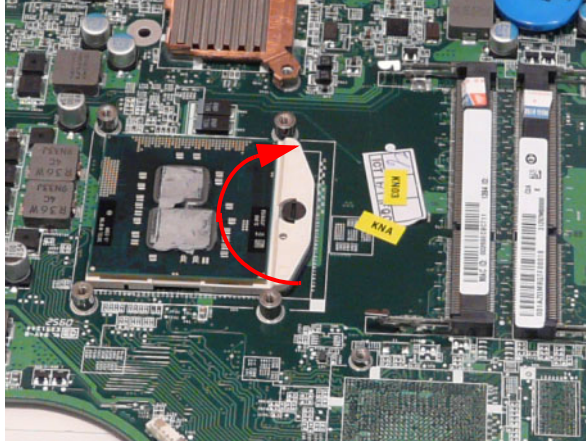

Replacing the Thermal Module

IMPORTANT: Apply a suitable thermal grease and ensure all heat pads are in place before replacing the Thermal Module.

The following thermal grease types are approved for use:

- Silmore GP50
- Honeywell
- Jet Motor 7762

The following thermal pads are approved for use:

- Eapus XR-PE
1. Remove all traces of thermal grease from the CPU using a lint-free cloth or cotton swab and Isopropyl Alcohol, Acetone (1), or other approved cleaning agent.
 2. Apply a small amount of thermal grease to the centre of the CPU—there is no need to spread the grease manually, the force used during the installation of the Thermal Module is sufficient.
 3. Align the screw holes on the Thermal Module and Mainboard then replace the module. Keep the module as level as possible to spread the thermal grease evenly.
 4. Replace the four (4) securing screws (in numerical order from screw 1 to screw 4) to secure the Thermal Module in place.

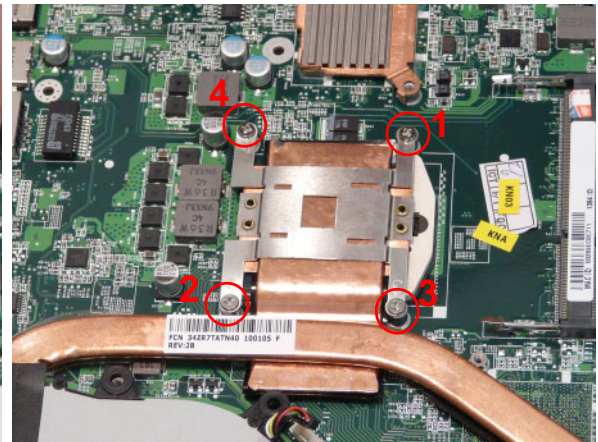
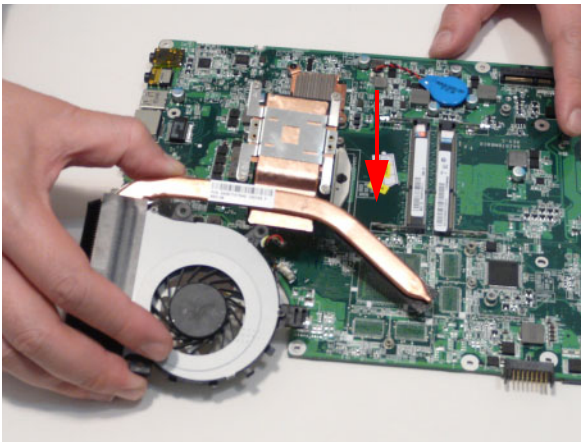

5. Connect the fan cable.

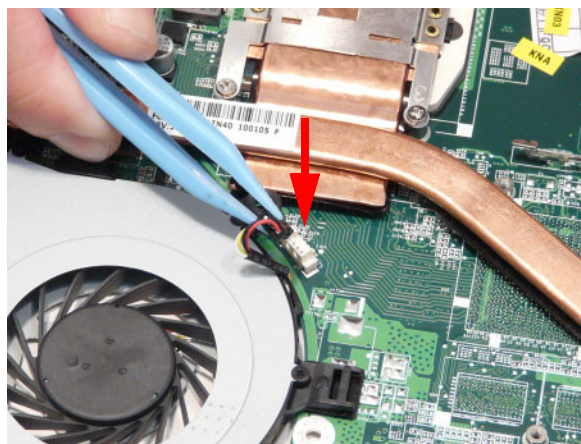

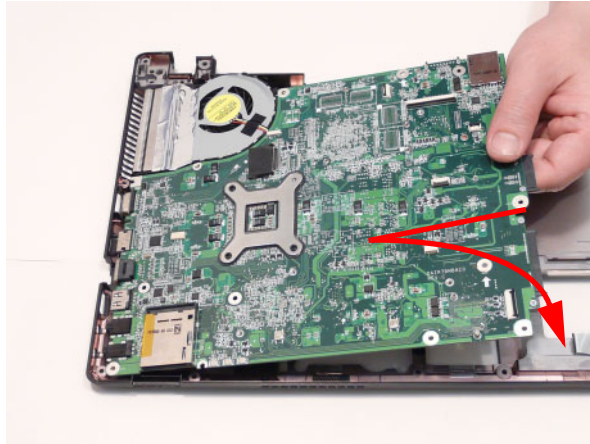

Replacing the Main Board

1. Slide the main board external connector edge in first to the lower case, then lower into place.

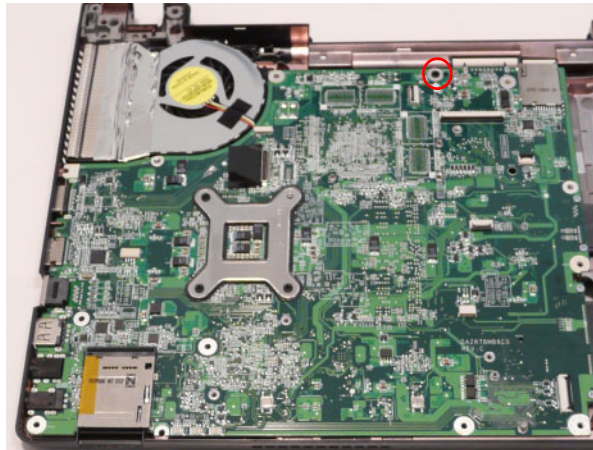

2. Replace the one (1) screw to secure the mainboard to the lower cover.



Step	Screw	Quantity	Screw Type
Mainboard Assembly	M2.5*5	1	

3. Turn the computer over and connect the power connector.



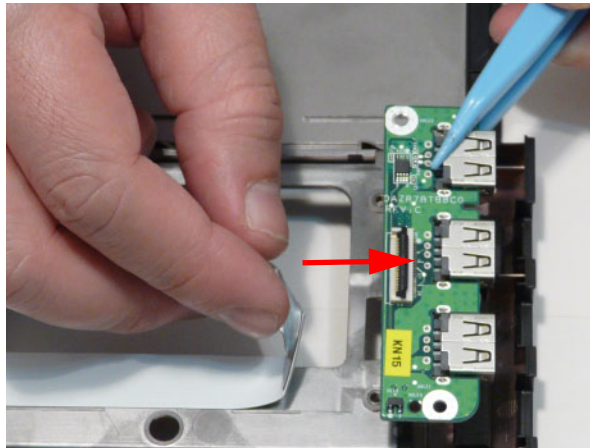

Replacing the USB Card

1. Place the USB card into the lower case external edge first.

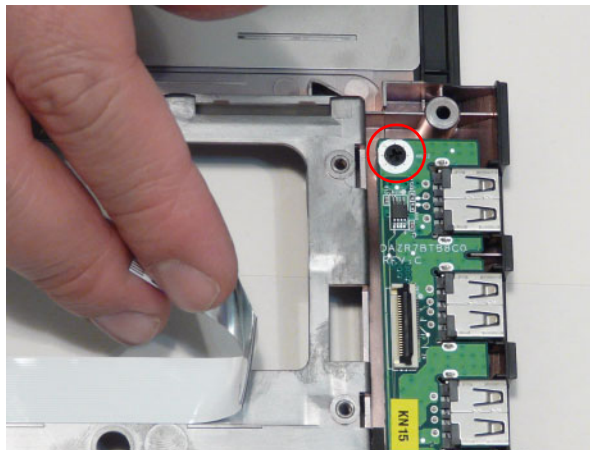

2. Replace the one (1) screw.



Step	Screw	Quantity	Screw Type
USB Card Assembly	M2.5x5	1	

3. Connect and lock the USB card FFC to the USB board.

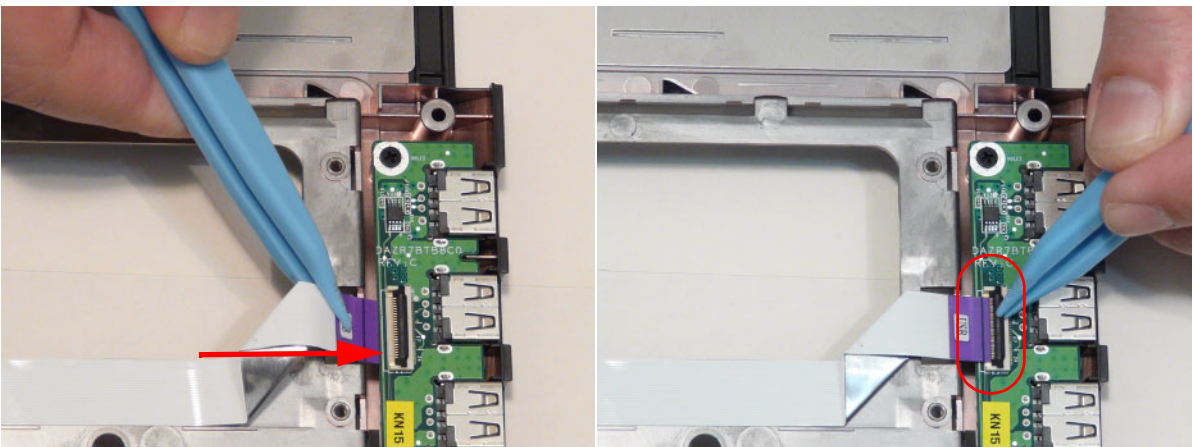

4. Connect and lock the USB card FFC to the mainboard.

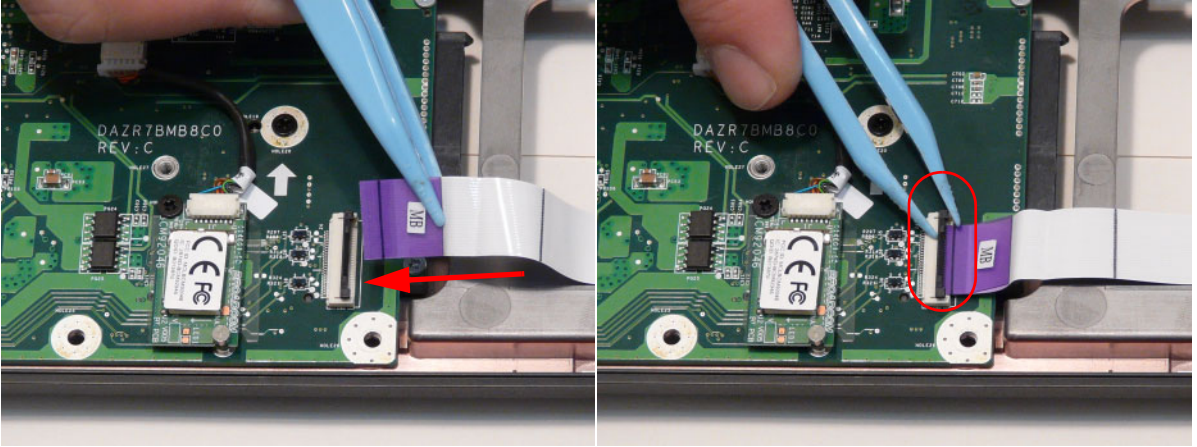

Replacing the Bluetooth Module

1. Connect the Bluetooth cable to the Bluetooth module.

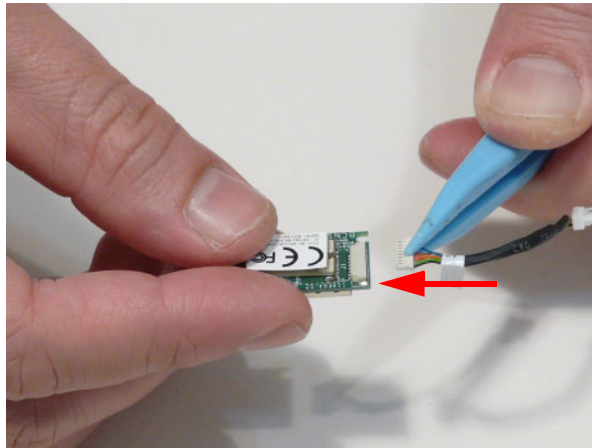

2. Place the Bluetooth module onto the mainboard pressing down firmly.

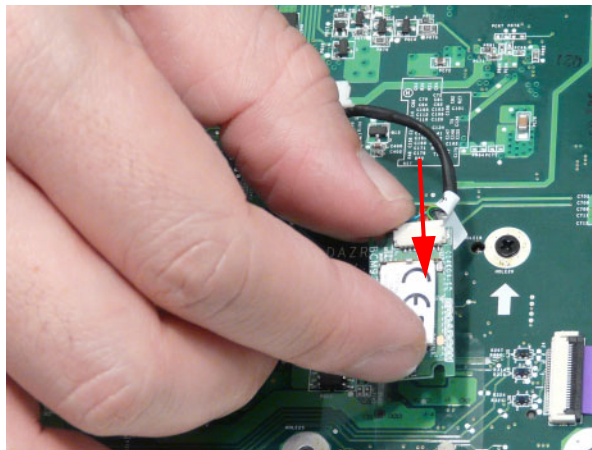

3. Replace the one (1) screw.

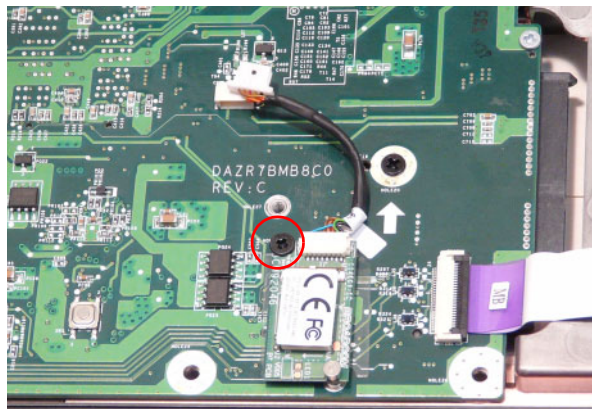

Step	Screw	Quantity	Screw Type.
Replace Bluetooth Module	M2.5*3	1	

-
4. Connect the Bluetooth module cable to the main board.

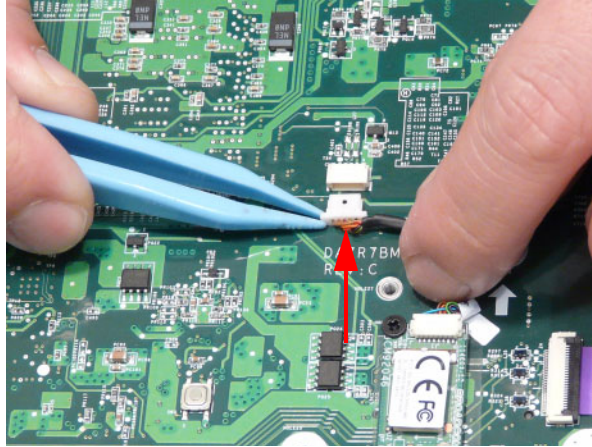

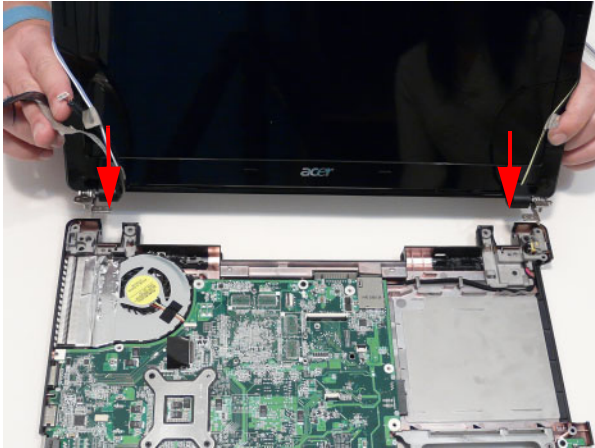

Replacing the LCD Module

1. Place the LCD module hinges into position on the lower case.

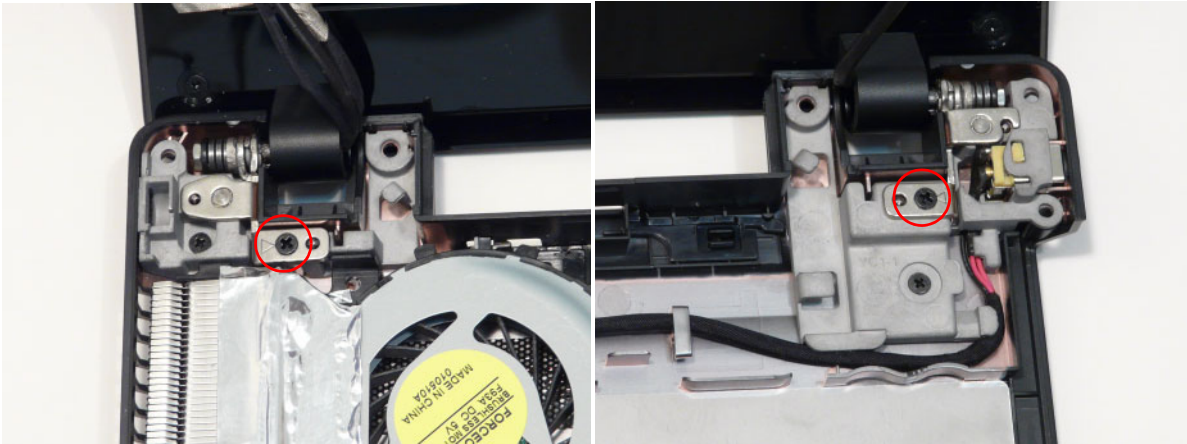

2. Replace the two (2) screws, one each in the left and right hinges.



Step	Screw	Quantity	Screw Type
LCD Module Assembly	M2.5x5	2	

3. Insert the right antenna cables through the lower cover and pull through from the other side.

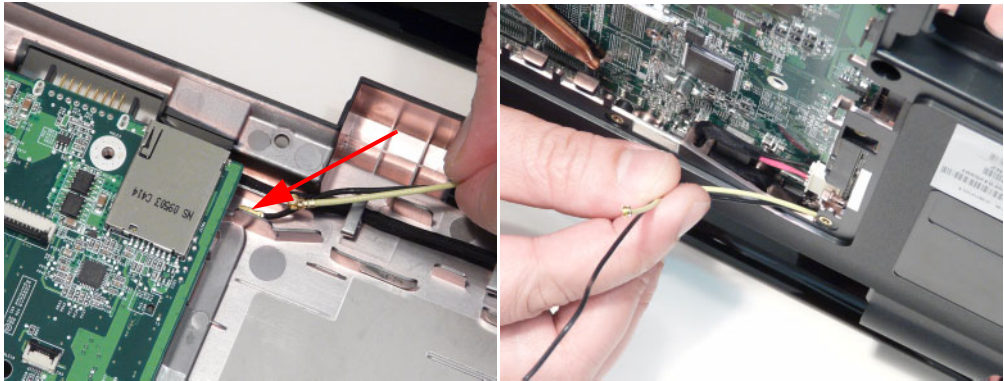

4. Lay the right antenna cables under the retention guides and adhere the tape.

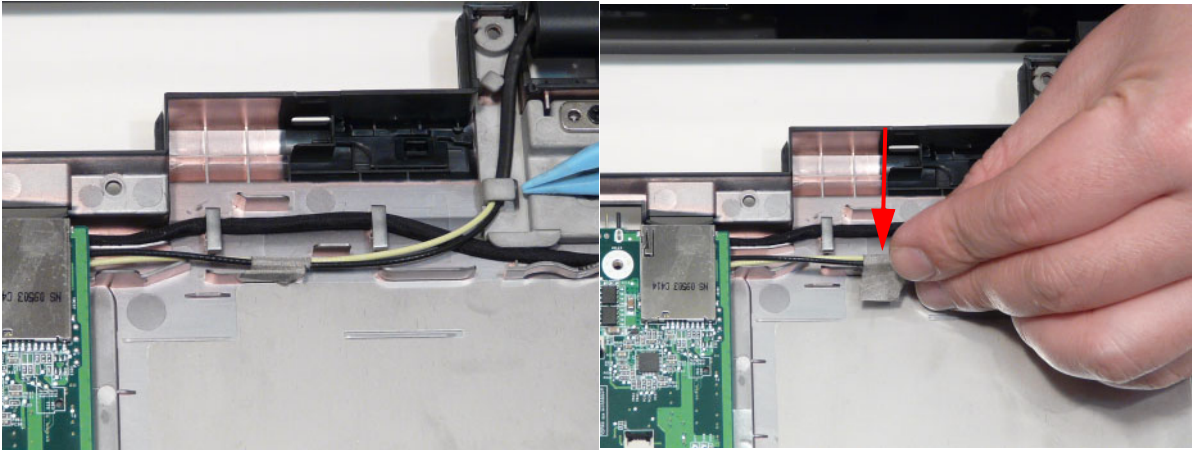

5. Push the left antenna cables through the lower cover and adhere the tape.

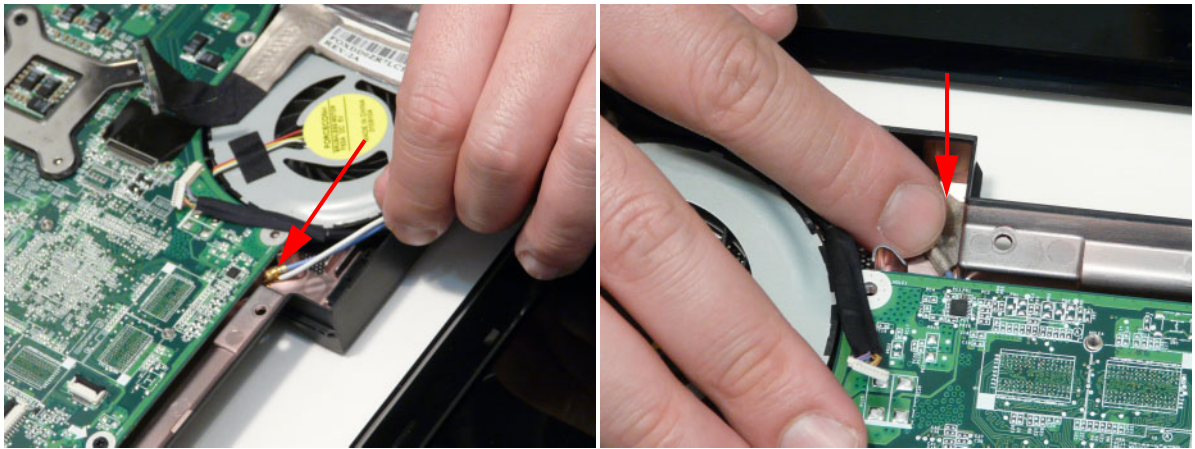

6. Lay the microphone cable in the location shown and press firmly to adhere the cable.

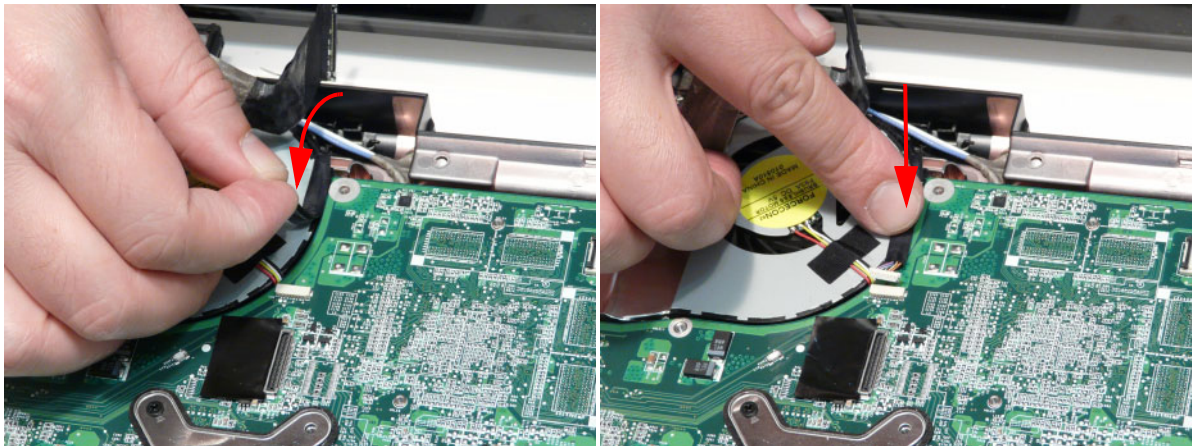

7. Connect the microphone cable.

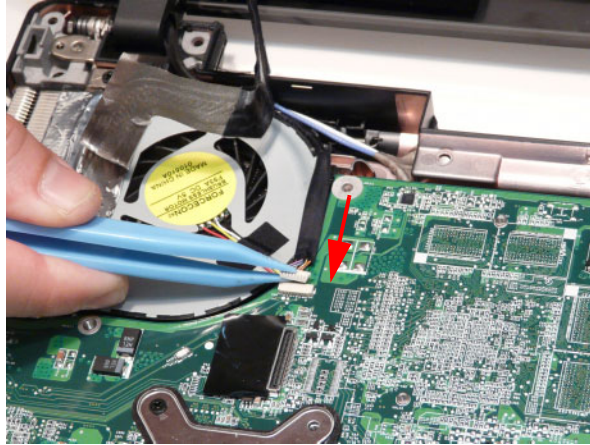

8. Lay the LVDS cable across the assembly as shown and press down firmly.

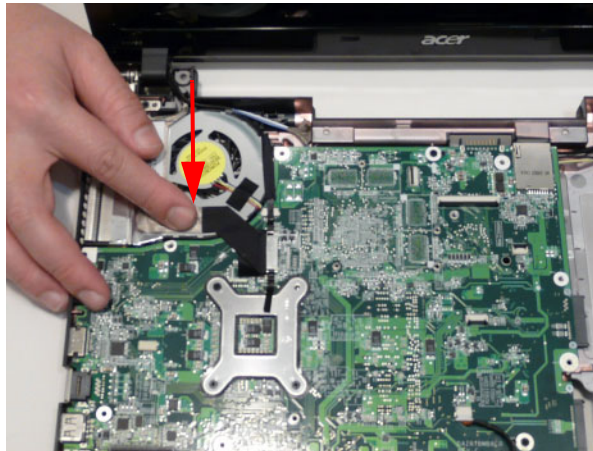

9. Connect the LVDC cable.

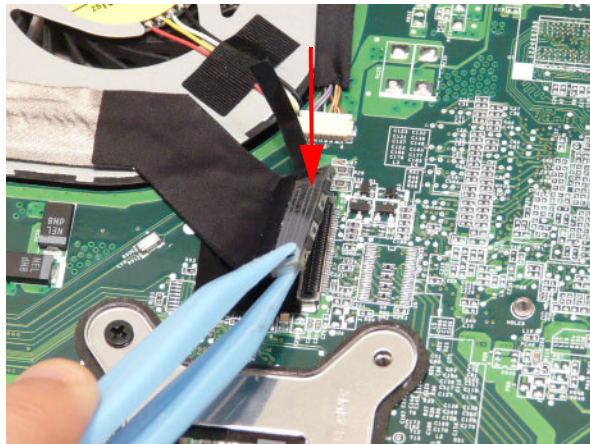

10. Press the LVDS connector left and right adhesive tabs down onto the mainboard.

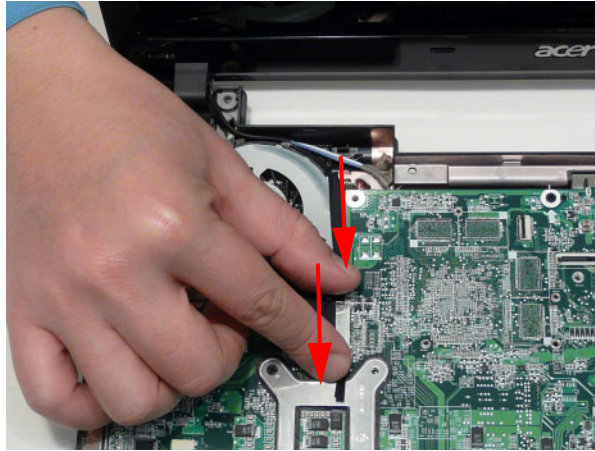

Replacing the Power Board

1. Place the power board into the upper cover.

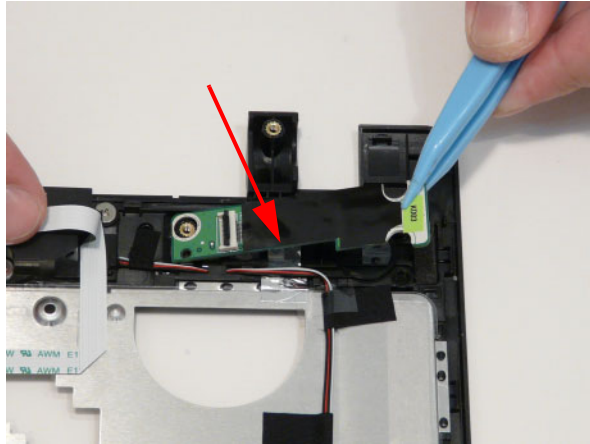

2. Replace the two (2) screws.

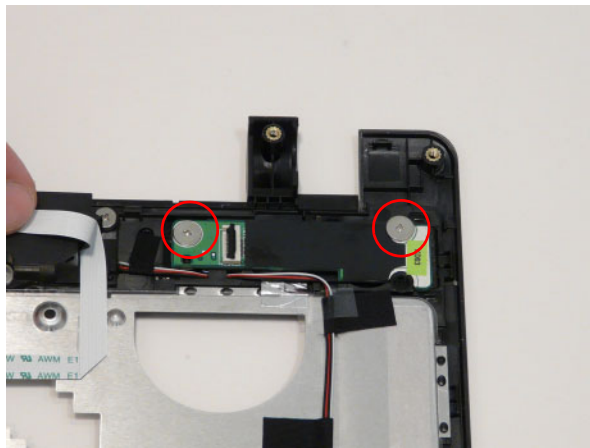

3. Connect and lock the FFC.

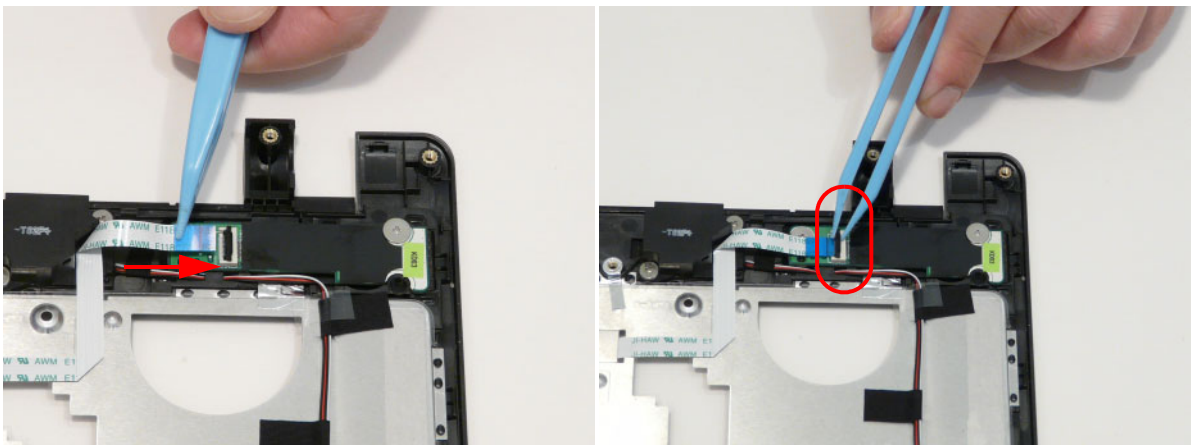

Replacing the Switch Board

1. Connect and lock the FFC.

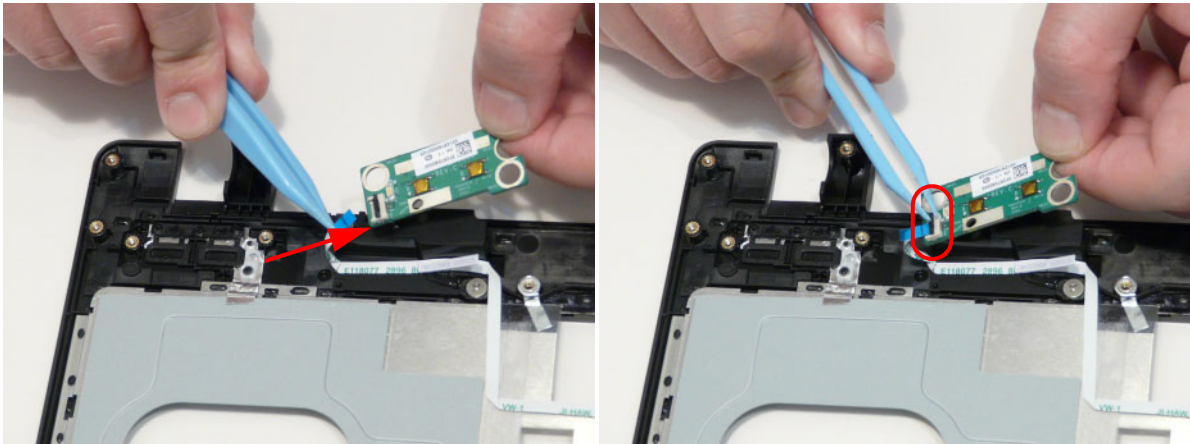

2. Turn the switch board over and place into the upper cover.

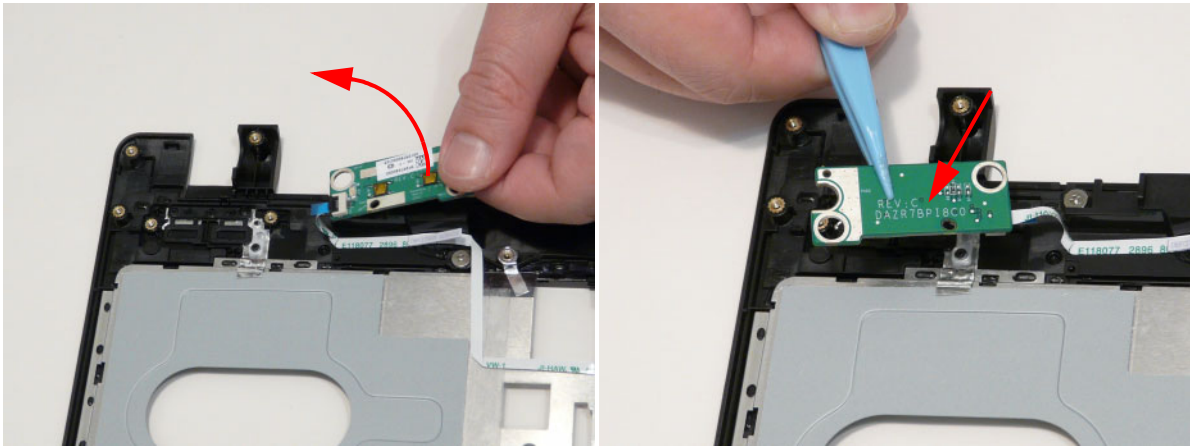

3. Replace the two (2) screws.

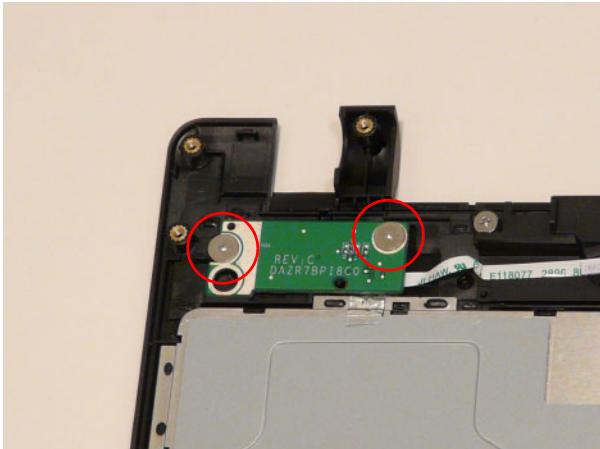

Step	Size	Quantity	Screw Type
Switch Board Assembly	T2.5*2	2	



Replacing the Upper Cover

- 1. Place the upper cover onto the lower cover aligning the hinges first and then press down around the edges.



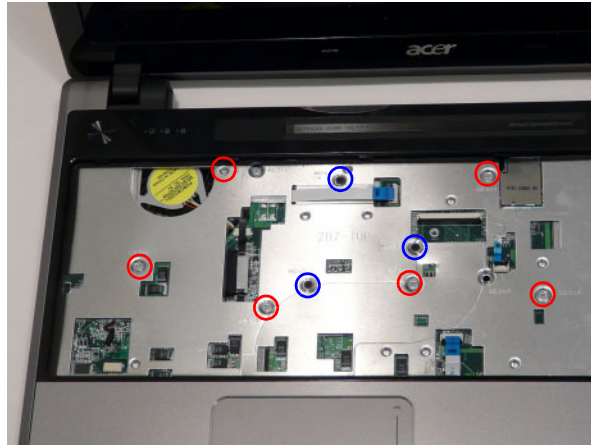

2. Replace the nine (9) screws.

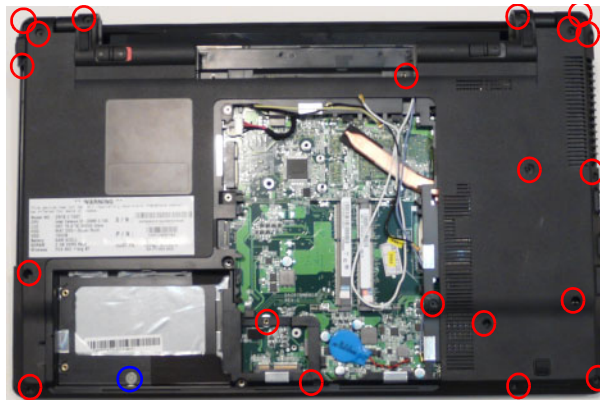

Step	Size	Quantity	Screw Type
Upper Cover Assembly	M2*3	3 (blue call out)	
	M2*5 Ni	6 (red call out)	

3. Turn the computer over and replace the bottom cover twenty-one (21) screws.



Step	Size	Quantity	Screw Type
Lower Cover Assembly	M2.5*5	20 (red call out)	
	T2.5*2	1 (blue call out)	

4. Connect the speaker cable.

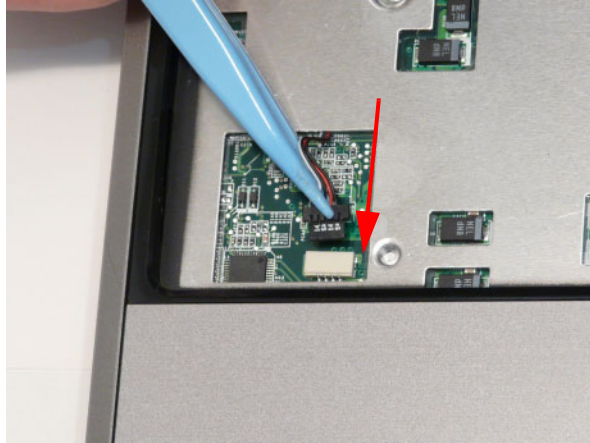

5. Connect and lock the switch board FFC.

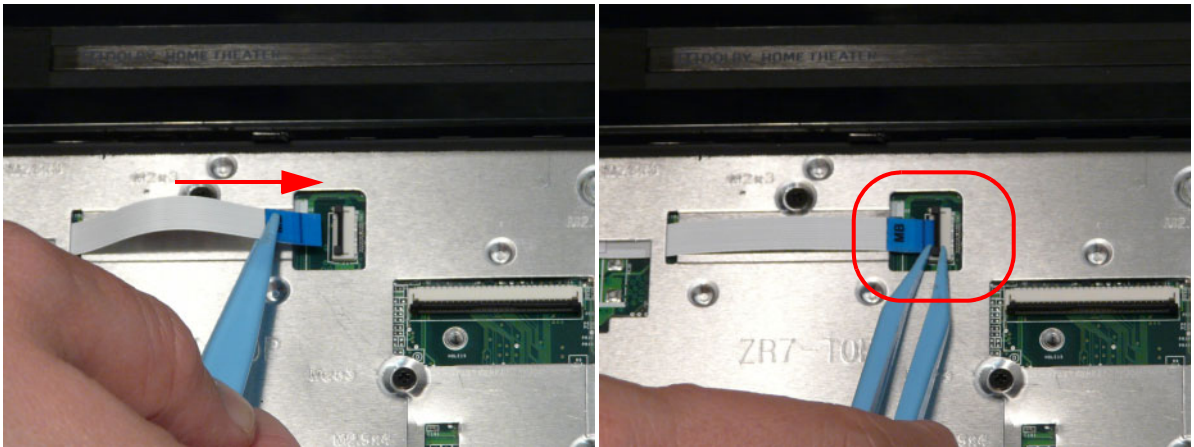

6. Connect and lock the power board FFC.

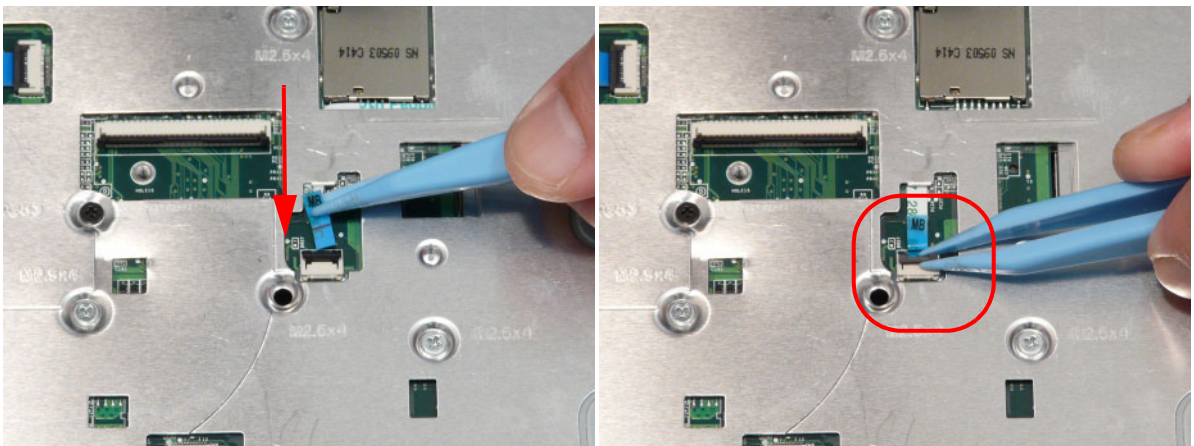

7. Connect and lock the button board FFC.

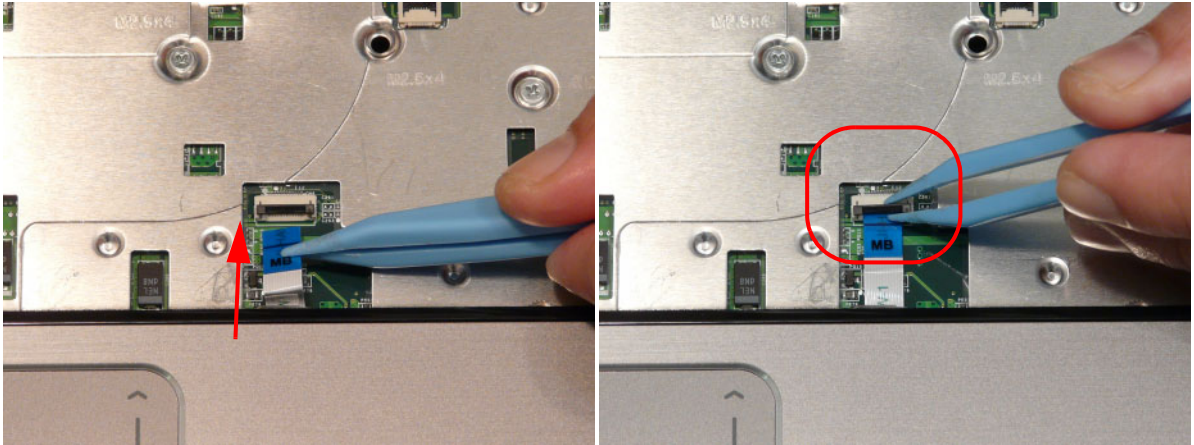

Replacing the Keyboard

1. Connect the FFC to the mainboard.



2. Turn the keyboard over and insert the bottom edge in first, then push to down ensure the five latches across the top are fully secured.



Replacing the Wireless LAN Module

1. Lay the white wireless LAN antenna cable into the retention guides.

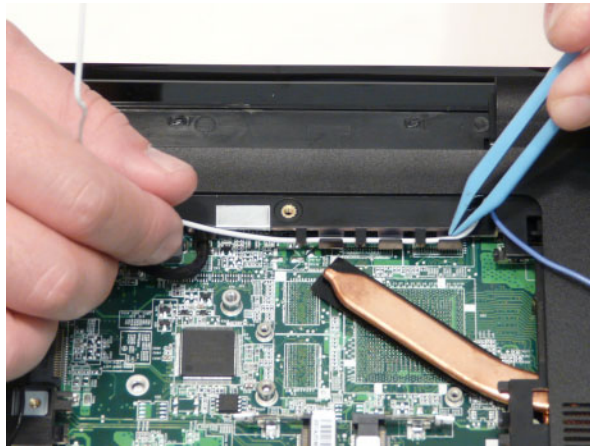

2. Lay the white and black wireless LAN antenna cables into the retention guides.

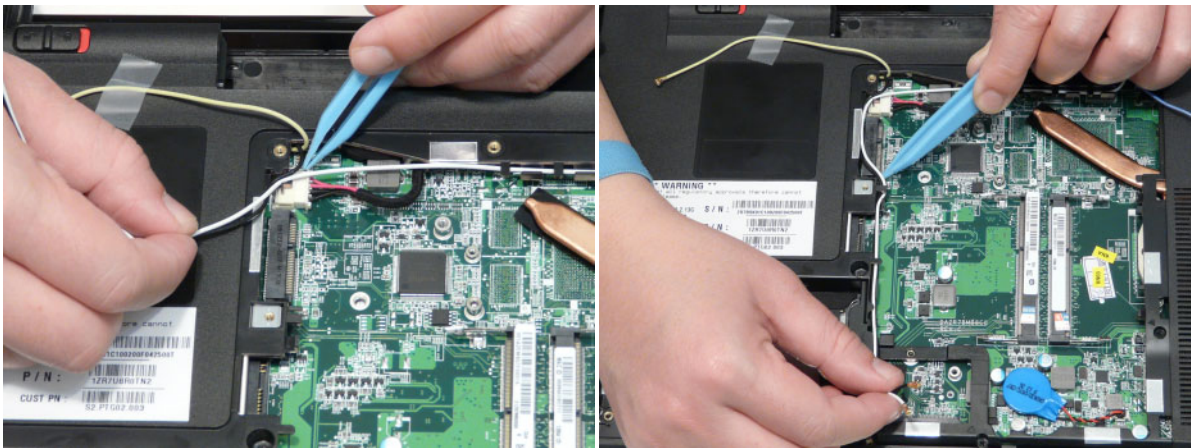

3. Insert the wireless LAN module into the connector.

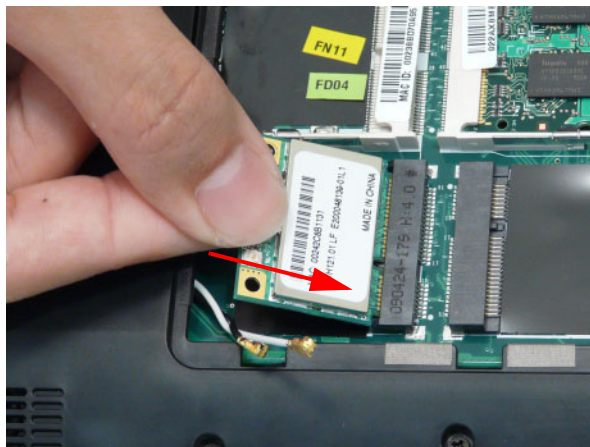

- Replace the one screw.



Step	Size	Quantity	Screw Type
WLAN Assembly	M2.5*3	1	

- Replace the connectors. The white (Aux) cable attaches to the connector marked **2** on the board. The black (Main) cable attaches to the connector marked **1** on the board.

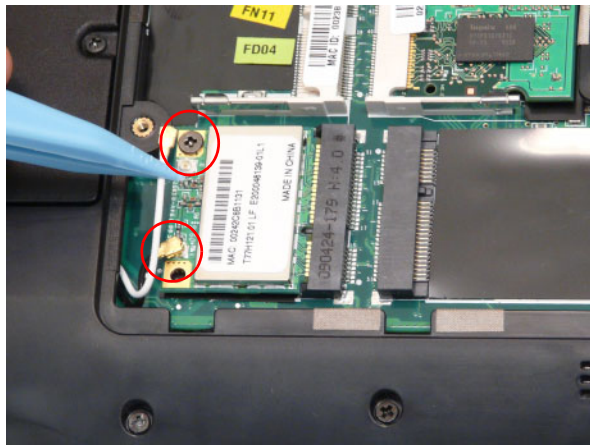

Replacing the DIMM Module

1. Slide the DIMM module into the connector.

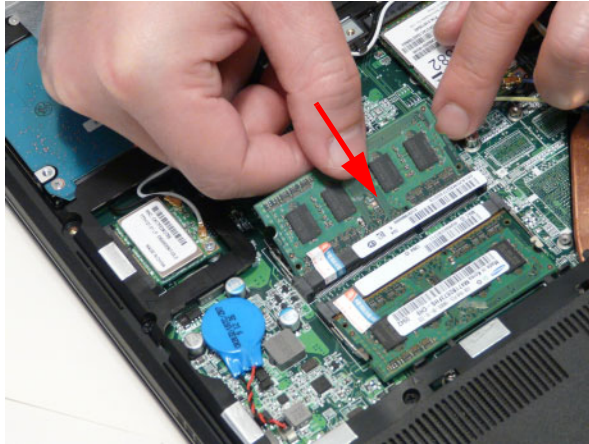

2. Press down till the locking springs click into place.



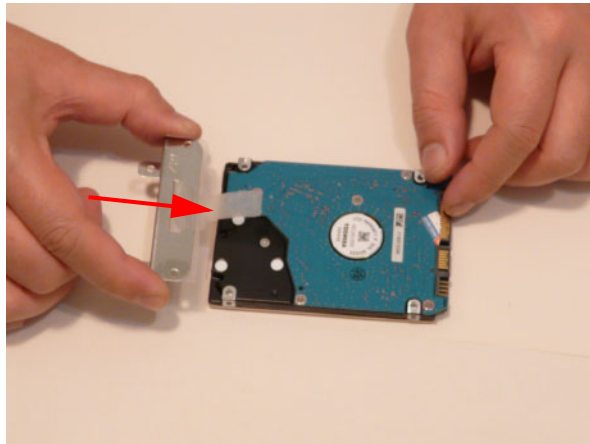

Replacing the Hard Disk Drive

1. Place the HDD bracket onto the HDD.

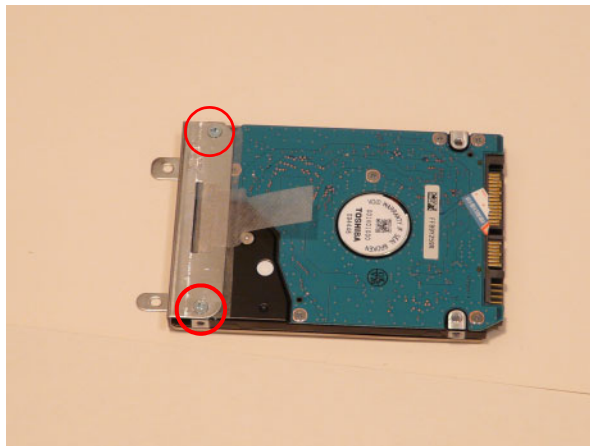

2. Replace the two (2) screws.



Step	Size	Quantity	Screw Type
HDD Assembly	M3*3	2	

3. Insert the HDD into the bay inserting the bracket flanges into the lower cover slots first.

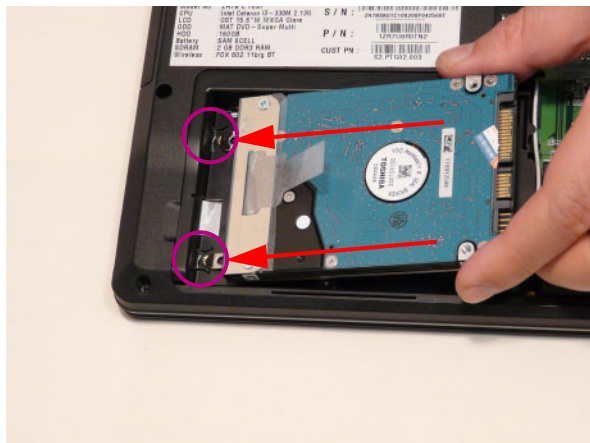

-
4. Grasp the tab and slide the HDD firmly into the docking connector.

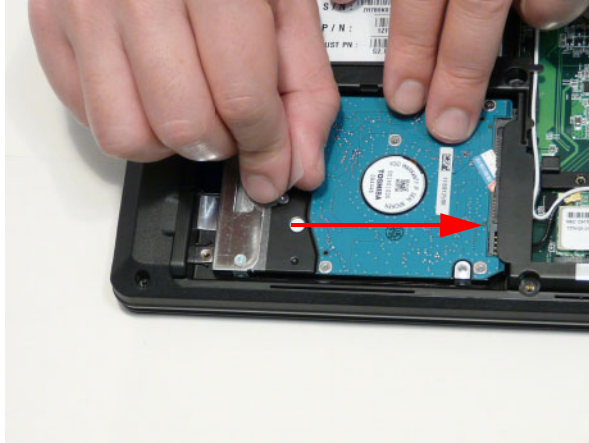

Replacing the RTC Battery

1. Place the RTC battery onto the mainboard and press down firmly.

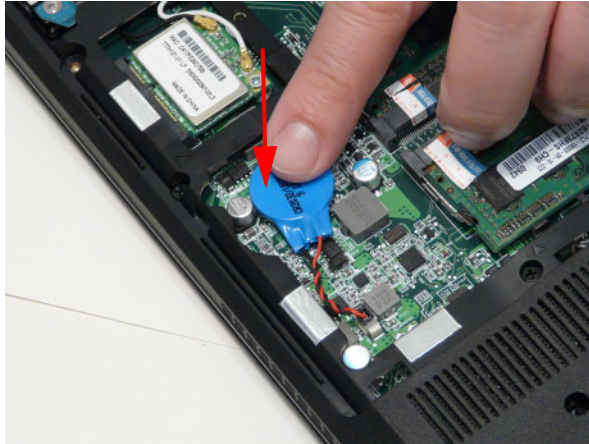

2. Connect the RTC battery cable to the mainboard.

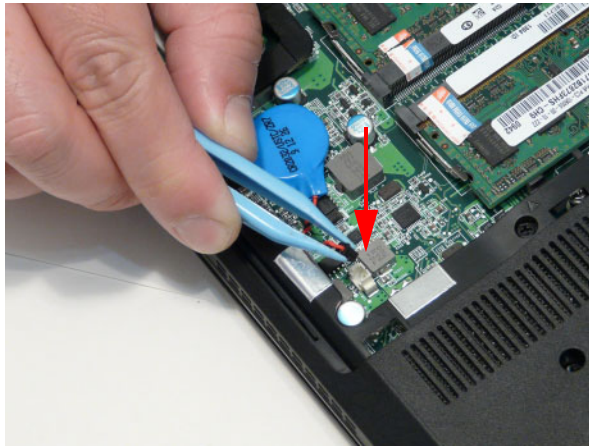

Replacing the ODD Module

1. Replace the ODD bezel.



2. Replace the ODD bracket.

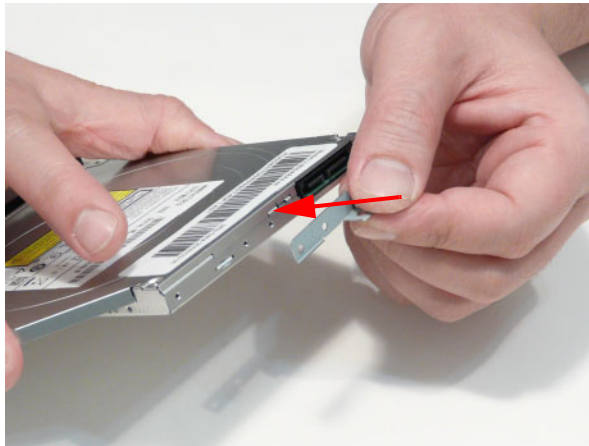

3. Replace the two (2) screws of the ODD bracket.



Step	Screw	Quantity	Screw Type
ODD Module Disassembly	M2*3Ni	2	

4. Push the ODD completely into the bay until flush with the lower cover.



Replacing the Base Door

1. Insert the base door edge flanges into the slots.

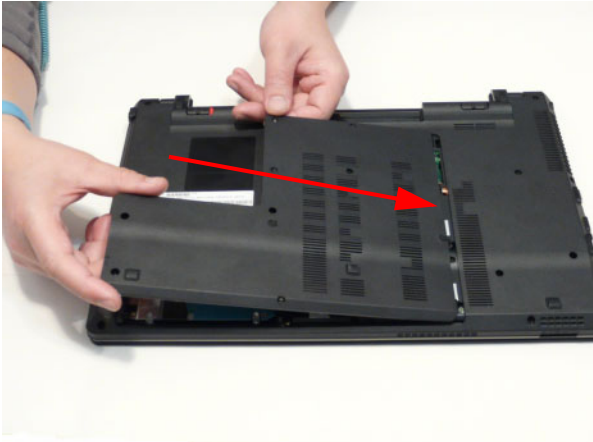

2. Lower the base door.



3. Replace the eight (8) screws.

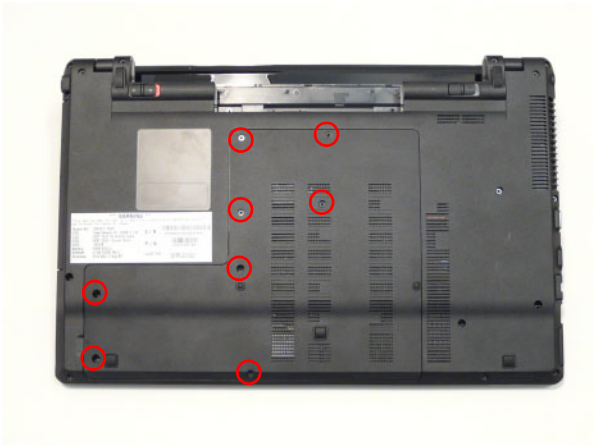

Step	Size	Quantity	Screw Type
Base Door Assembly	M2.5*8	8	

Replacing the Battery

1. Slide the battery into position.

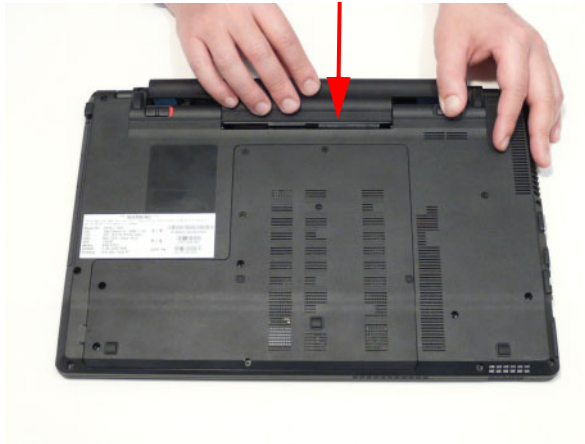

2. Close the locking latch.



Replace the Dummy Card

Push the dummy card into the slot until it clicks into place.



Troubleshooting

Common Problems

Use the following procedure as a guide for computer problems.

NOTE: The diagnostic tests are intended to test only Acer products. Non-Acer products, prototype cards, or modified options can give false errors and invalid system responses.

1. Obtain the failing symptoms in as much detail as possible.
2. Verify the symptoms by attempting to re-create the failure by running the diagnostic test or by repeating the same operation.
3. Use the following table with the verified symptom to determine which page to go to.

Symptoms (Verified)	Go To
Power On Issue	Page 150
No Display Issue	Page 151
LCD Failure	Page 153
Internal Keyboard Failure	Page 154
TouchPad Failure	Page 155
Internal Speaker Failure	Page 156
Internal Microphone Failure	Page 157
USB Failure	Page 159
Other Function Failure	Page 159

4. If the Issue is still not resolved, see "Online Support Information" on page 219.

Power On Issue

If the system doesn't power on, perform the following actions one at a time to correct the problem. Do not replace non-defective FRUs:

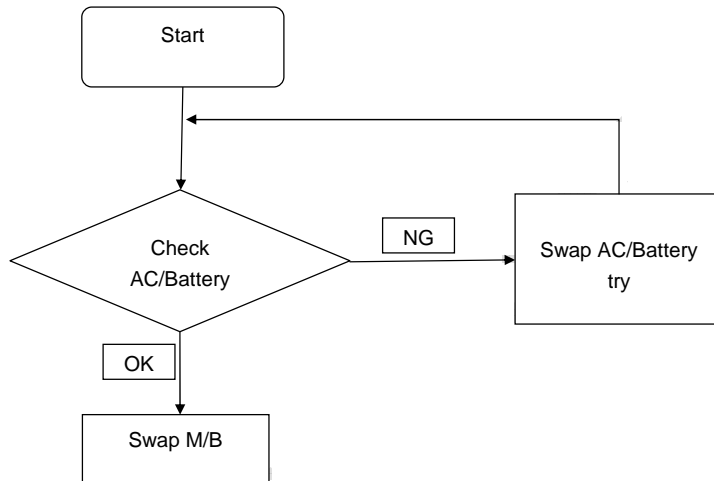

Computer Shuts down Intermittently

If the system powers off at intervals, perform the following actions one at a time to correct the problem.

1. Check the power cable is properly connected to the computer and the electrical outlet.
2. Remove any extension cables between the computer and the outlet.
3. Remove any surge protectors between the computer and the electrical outlet. Plug the computer directly into a known good electrical outlet.
4. Remove all external and non-essential hardware connected to the computer that are not necessary to boot the computer to the failure point.
5. Remove any recently installed software.
6. If the Issue is still not resolved, see "Online Support Information" on page 219.

No Display Issue

If the **Display** doesn't work, perform the following actions one at a time to correct the problem. Do not replace non-defective FRUs:

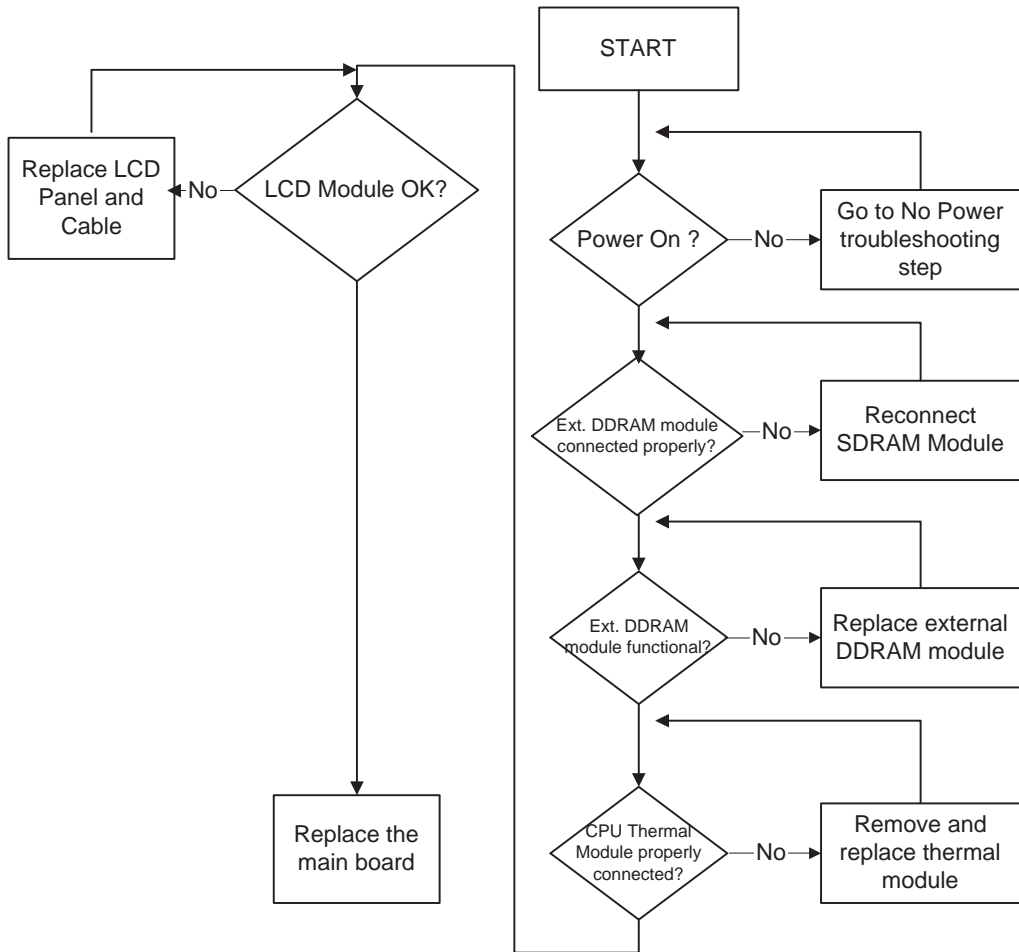

No POST or Video

If the POST or video doesn't display, perform the following actions one at a time to correct the problem.

1. Make sure that the internal display is selected. On this notebook model, switching between the internal display and the external display is done by pressing **Fn+F5**. Reference Product pages for specific model procedures.
2. Make sure the computer has power by checking at least one of the following occurs:
 - Fans start up
 - Status LEDs light up

If there is no power, see “Power On Issue” on page 150.

3. Drain any stored power by removing the power cable and battery and holding down the power button for 10 seconds. Reconnect the power and reboot the computer.
4. Connect an external monitor to the computer and switch between the internal display and the external display is by pressing **Fn+F5** (on this model).

If the POST or video appears on the external display, see “LCD Failure” on page 153.

5. Disconnect power and all external devices including port replicators or docking stations. Remove any memory cards and CD/DVD discs. Restart the computer.

If the computer boots correctly, add the devices one by one until the failure point is discovered.

6. Reseat the memory modules.
7. Remove the drives (see “Disassembly Process” on page 51).
8. If the Issue is still not resolved, see “Online Support Information” on page 219.

Abnormal Video Display

If video displays abnormally, perform the following actions one at a time to correct the problem.

1. Reboot the computer.
2. If permanent vertical/horizontal lines or dark spots display in the same location, the LCD is faulty and should be replaced. See “Disassembly Process” on page 51.
3. If extensive pixel damage is present (different colored spots in the same locations on the screen), the LCD is faulty and should be replaced. See “Disassembly Process” on page 51.
4. Adjust the brightness to its highest level. See the User Manual for instructions on adjusting settings.
NOTE: Ensure that the computer is not running on battery alone as this may reduce display brightness.

If the display is too dim at the highest brightness setting, the LCD is faulty and should be replaced. See “Disassembly Process” on page 51.

5. Check the display resolution is correctly configured:
 - a. Minimize or close all Windows.
 - b. If display size is only abnormal in an application, check the view settings and control/mouse wheel zoom feature in the application.
 - c. If desktop display resolution is not normal, right-click on the desktop and select **Personalize**→ **Display Settings**.
 - d. Click and drag the Resolution slider to the desired resolution.
 - e. Click **Apply** and check the display. Readjust if necessary.
6. Roll back the video driver to the previous version if updated.
7. Remove and reinstall the video driver.
8. Check the Device Manager to determine that:
 - The device is properly installed. There are no red Xs or yellow exclamation marks.
 - There are no device conflicts.
 - No hardware is listed under Other Devices.
9. If the Issue is still not resolved, see “Online Support Information” on page 219.
10. Run the Windows Memory Diagnostic from the operating system DVD and follow the onscreen prompts.
11. If the Issue is still not resolved, see “Online Support Information” on page 219.

Random Loss of BIOS Settings

If the computer is experiencing intermittent loss of BIOS information, perform the following actions one at a time to correct the problem.

1. If the computer is more than one year old, replace the CMOS battery.
2. Run a complete virus scan using up-to-date software to ensure the computer is virus free.
3. If the computer is experiencing HDD or ODD BIOS information loss, disconnect and reconnect the power and data cables between devices.

If the BIOS settings are still lost, replace the cables.

4. If HDD information is missing from the BIOS, the drive may be defective and should be replaced.
5. Replace the Motherboard.

6. If the Issue is still not resolved, see "Online Support Information" on page 219.

LCD Failure

If the **LCD** fails, perform the following actions one at a time to correct the problem. Do not replace non-defective FRUs:

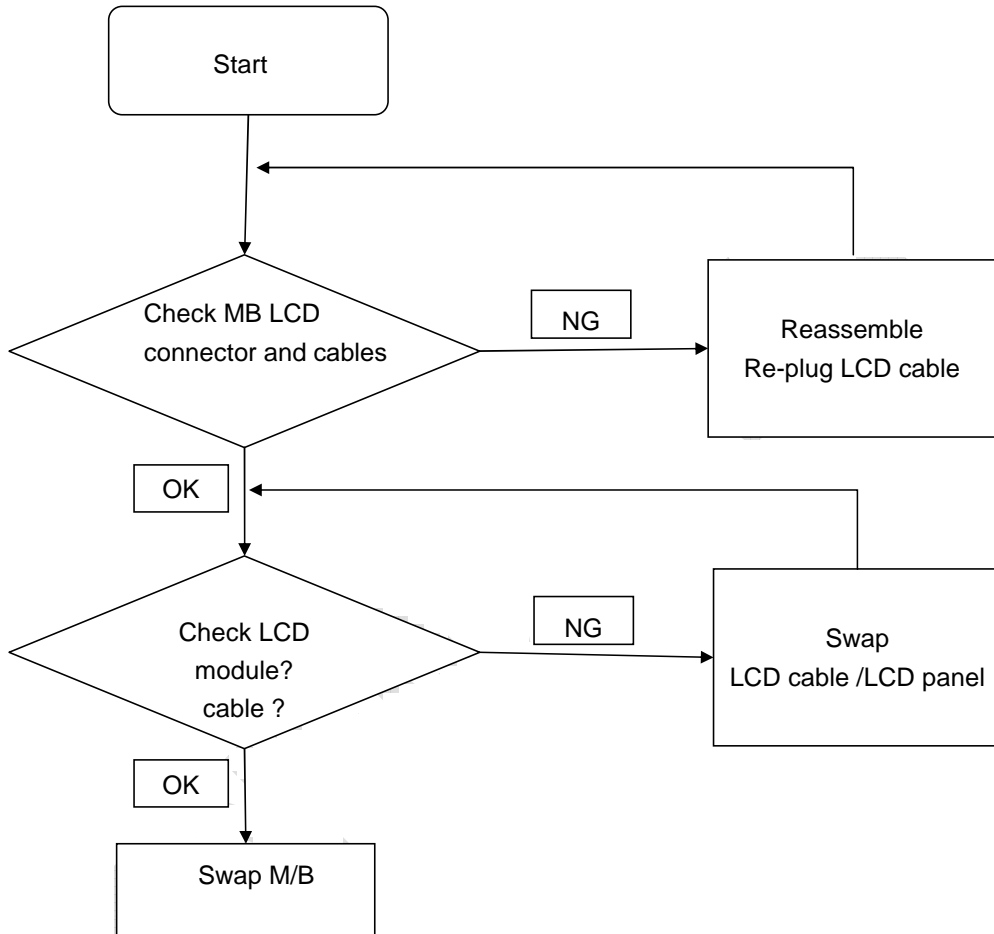

Built-In Keyboard Failure

If the built-in **Keyboard** fails, perform the following actions one at a time to correct the problem. Do not replace non-defective FRUs:

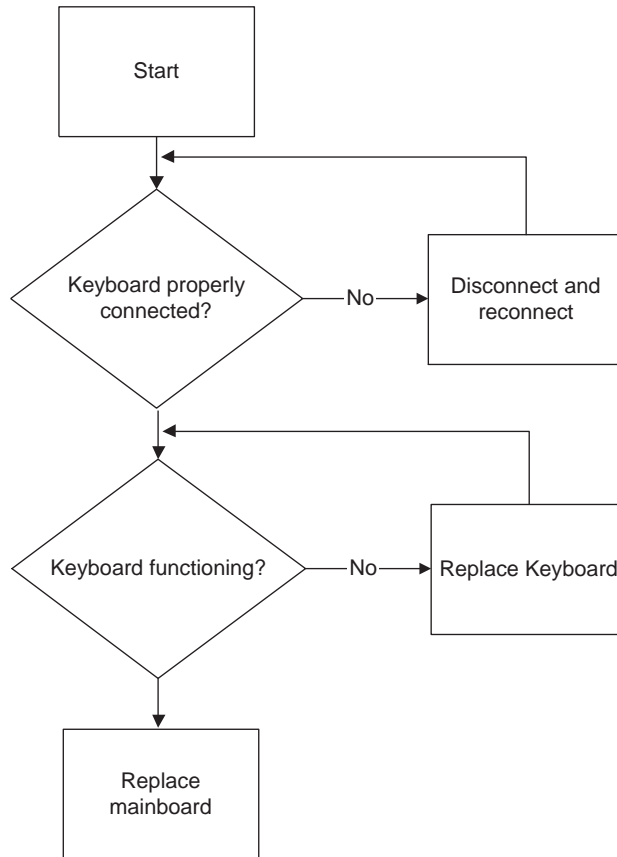

TouchPad Failure

If the **TouchPad** doesn't work, perform the following actions one at a time to correct the problem. Do not replace non-defective FRUs:

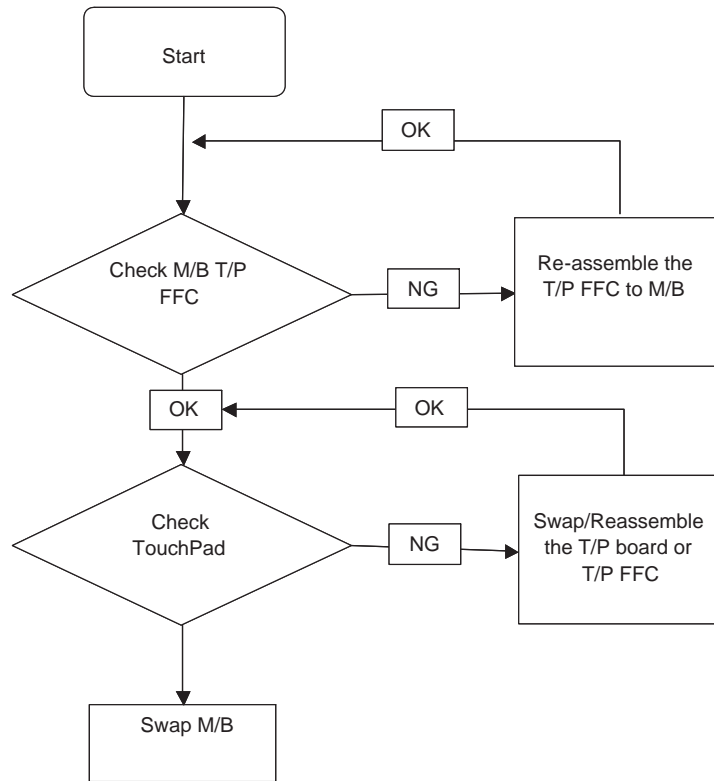

Internal Speaker Failure

If the internal **Speakers** fail, perform the following actions one at a time to correct the problem. Do not replace non-defective FRUs:

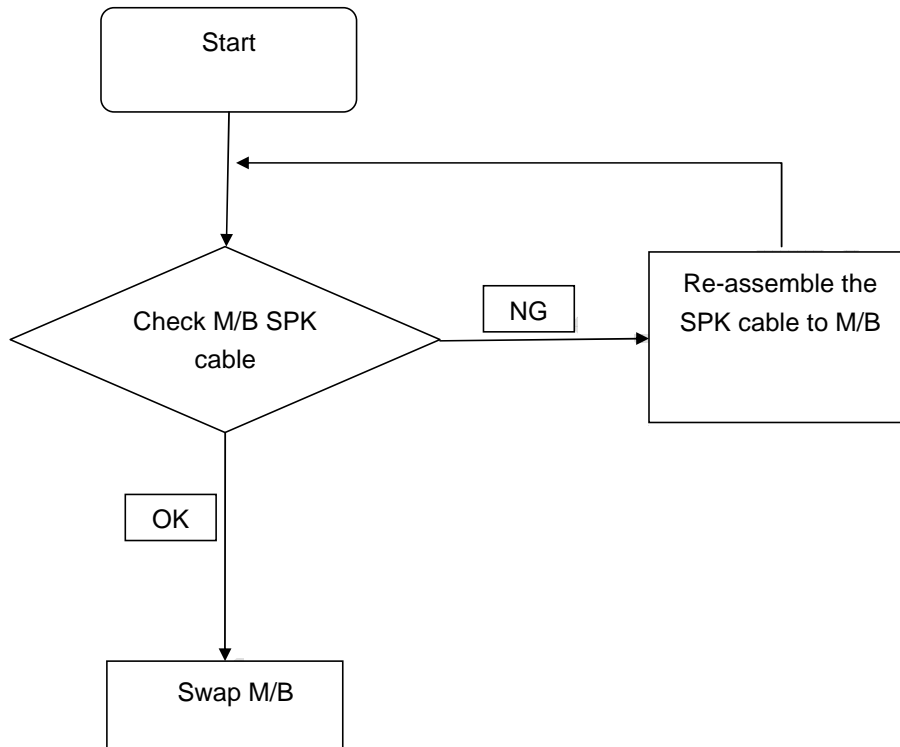

Sound Problems

If sound problems are experienced, perform the following actions one at a time to correct the problem.

1. Reboot the computer.
2. Navigate to **Start** → **Control Panel** → **System and Maintenance** → **System** → **Device Manager**. Check the Device Manager to determine that:
 - The device is properly installed.
 - There are no red Xs or yellow exclamation marks.
 - There are no device conflicts.
 - No hardware is listed under Other Devices.
3. Roll back the audio driver to the previous version, if updated recently.
4. Remove and reinstall the audio driver.
5. Ensure that all volume controls are set mid range:
 - a. Click the volume icon on the taskbar and drag the slider to 50. Ensure that the volume is not muted.
 - b. Click Mixer to verify that other audio applications are set to 50 and not muted.
6. Navigate to **Start** → **Control Panel** → **Hardware and Sound** → **Sound**. Ensure that Speakers are selected as the default audio device (green check mark).

NOTE: If Speakers does not show, right-click on the **Playback** tab and select **Show Disabled Devices** (clear by default).
7. Select Speakers and click **Configure** to start **Speaker Setup**. Follow the onscreen prompts to configure the speakers.
8. Remove and recently installed hardware or software.

9. Restore system and file settings from a known good date using **System Restore**.
If the issue is not fixed, repeat the preceding steps and select an earlier time and date.
10. Reinstall the Operating System.
11. If the Issue is still not resolved, see “Online Support Information” on page 219.

Internal Microphone Failure

If the internal **Microphone** fails, perform the following actions one at a time to correct the problem. Do not replace non-defective FRUs:

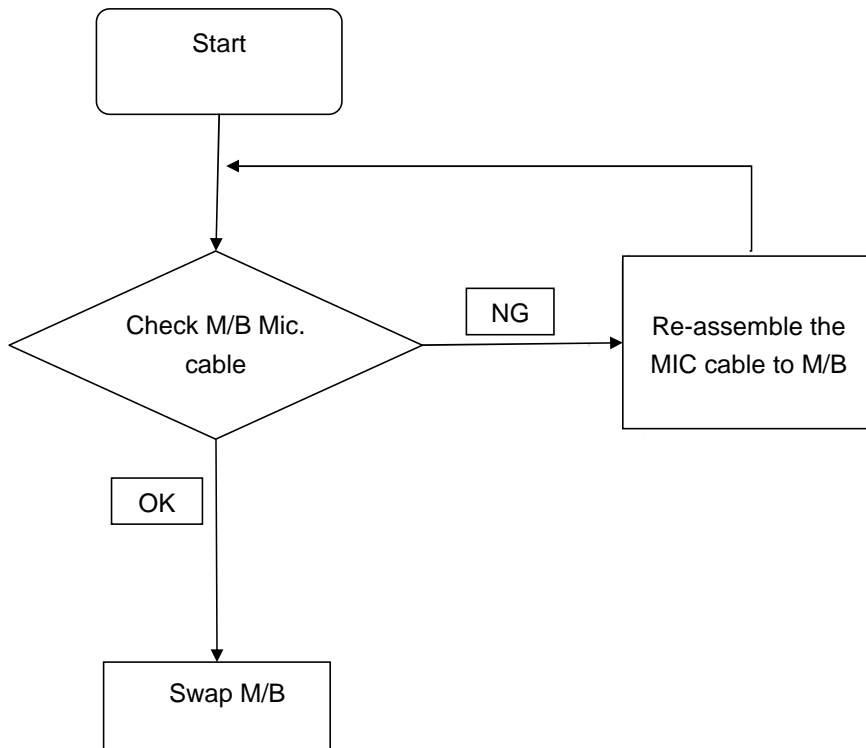

Microphone Problems

If internal or external **Microphones** do not operate correctly, perform the following actions one at a time to correct the problem.

1. Check that the microphone is enabled. Navigate to **Start** → **Control Panel** → **Hardware and Sound** → **Sound** and select the **Recording** tab.
2. Right-click on the **Recording** tab and select **Show Disabled Devices** (clear by default).
3. The microphone appears on the **Recording** tab.
4. Right-click on the microphone and select **Enable**.
5. Select the microphone then click **Properties**. Select the **Levels** tab.
6. Increase the volume to the maximum setting and click **OK**.
7. Test the microphone hardware:
 - a. Select the microphone and click **Configure**.
 - b. Select **Set up microphone**.
 - c. Select the microphone type from the list and click **Next**.
 - d. Follow the onscreen prompts to complete the test.

-
8. If the Issue is still not resolved, see “Online Support Information” on page 219.

HDD Not Operating Correctly

If the **HDD** does not operate correctly, perform the following actions one at a time to correct the problem.

1. Disconnect all external devices.
2. Run a complete virus scan using up-to-date software to ensure the computer is virus free.
3. Run the Windows 7 Startup Repair Utility:
 - a. insert the Windows 7 Operating System DVD in the ODD and restart the computer.
 - b. When prompted, press any key to start to the operating system DVD.
 - c. The **Install Windows** screen displays. Click **Next**.
 - d. Select **Repair your computer**.
 - e. The **System Recovery Options** screen displays. Click **Next**.
 - f. Select the appropriate operating system, and click **Next**.

NOTE: Click **Load Drivers** if controller drives are required.

- g. Select **Startup Repair**.
- h. Startup Repair attempts to locate and resolve issues with the computer.
- i. When complete, click **Finish**.

If an issue is discovered, follow the onscreen information to resolve the problem.

4. Run the Windows Memory Diagnostic Tool. For more information see Windows Help and Support.
5. Restart the computer and press F2 to enter the BIOS Utility. Check the BIOS settings are correct and that CD/DVD drive is set as the first boot device on the Boot menu.
6. Ensure all cables and jumpers on the HDD and ODD are set correctly.
7. Remove any recently added hardware and associated software.
8. Run the Windows Disk Defragmenter. For more information see Windows Help and Support.
9. Run Windows Check Disk by entering **chkdsk /r** from a command prompt. For more information see Windows Help and Support.
10. Restore system and file settings from a known good date using **System Restore**.
If the issue is not fixed, repeat the preceding steps and select an earlier time and date.
11. Replace the HDD. See “Disassembly Process” on page 51.

USB Failure

If the rightside **USB** port fails, perform the following actions one at a time to correct the problem. Do not replace non-defective FRUs:

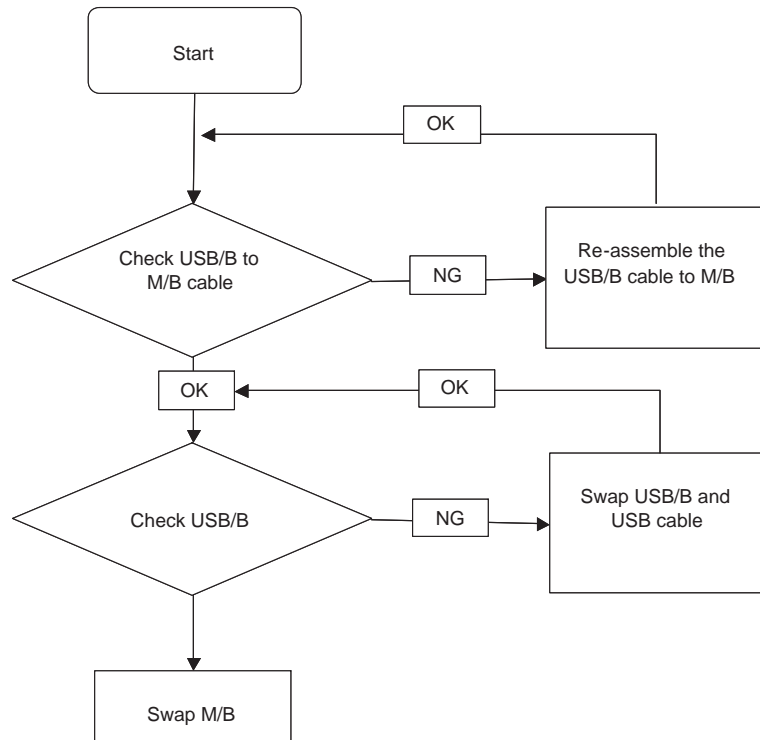

Other Failures

If the VGA board, LAN Port, external MIC or Speakers, PCI Express Card, 5-in-1 Card Reader or Volume Wheel fail, perform the following general steps to correct the problem. Do not replace non-defective FRUs:

1. Check whether the drive is OK.
2. Verify that the Test Fixture is OK.
3. Swap the mainboard and retest.

Intermittent Problems

Intermittent system hang problems can be caused by a variety of reasons that have nothing to do with a hardware defect, such as: cosmic radiation, electrostatic discharge, or software errors. FRU replacement should be considered only when a recurring problem exists.

When analyzing an intermittent problem, do the following:

1. Run the advanced diagnostic test for the system board in loop mode at least 10 times.
2. If no error is detected, do not replace any FRU.
3. If any error is detected, replace the FRU. Rerun the test to verify that there are no more errors.

Undetermined Problems

The diagnostic problems does not identify which adapter or device failed, which installed devices are incorrect, whether a short circuit is suspected, or whether the system is inoperative.

Follow these procedures to isolate the failing FRU (do not isolate non-defective FRU).

NOTE: Verify that all attached devices are supported by the computer.

NOTE: Verify that the power supply being used at the time of the failure is operating correctly. (See “Power On Issue” on page 150.):

1. Power-off the computer.
2. Visually check them for damage. If any problems are found, replace the FRU.
3. Remove or disconnect all of the following devices:
 - Non-Acer devices
 - Printer, mouse, and other external devices
 - Battery pack
 - Hard disk drive
 - DIMM
 - CD-ROM/Diskette drive Module
 - PC Cards
4. Power-on the computer.
5. Determine if the problem has changed.
6. If the problem does not recur, reconnect the removed devices one at a time until you find the failing FRU.
7. If the problem remains, replace the following FRU one at a time. Do not replace a non-defective FRU:
 - System board
 - LCD assembly

POST Code Reference Tables

These tables describe the POST codes and components of the POST process.

Post Code Range

Code	POST Routine Description
02h	Verify Real Mode
03h	Disable Non-Maskable Interrupt (NMI)
04h	Get CPU type
06h	Initialize system hardware
08h	Initialize chipset with initial POST values
09h	Set IN POST flag
0Ah	Initialize CPU registers
0Bh	Enable CPU cache
0Ch	Initialize caches to initial POST values
0Eh	Initialize USB component

Code	Beeps	POST Routine Description
0Fh		Initialize the local bus IDE
10h		Initialize Power Management
11h		Load alternate registers with initial POST values
12h		Restore CPU control word during warm boot
13h		Initialize PCI Bus Mastering devices
14h		Initialize keyboard controller
16h	1-2-2-3	BIOS ROM checksum
17h		Initialize cache before memory autosize
18h		8254 timer initialization
1Ah		8237 DMA controller initialization
1Ch		Reset Programmable Interrupt Controller
20h	1-3-1-1	Test DRAM refresh
22h	1-3-1-3	Test 8742 Keyboard Controller
24h		Set ES segment register to 4 GB
26h		Enable A20 line
28h		Autosize DRAM
29h		Initialize POST Memory Manager
2Ah		Clear 512 KB base RAM
2Ch	1-3-4-1	RAM failure on address line xxxx*
2Eh	1-3-4-3	RAM failure on data bits xxxx* of low byte of memory bus
2Fh		Enable cache before system BIOS shadow
30h	1-4-1-1	RAM failure on data bits xxxx* of high byte of memory bus
32h		Test CPU bus-clock frequency
33h		Initialize Phoenix Dispatch Manager
36h		Warm start shut down

Code	Beeps	POST Routine Description
38h		Shadow system BIOS ROM
3Ah		Autosize cache
3Ch		Advanced configuration of chipset registers
3Dh		Load alternate registers with CMOS values
42h		Initialize interrupt vectors
45h		POST device initialization
46h	2-1-2-3	Check ROM copyright notice
48h		Check video configuration against CMOS
49h		Initialize PCI bus and devices
4Ah		Initialize all video adapters in system
4Bh		QuietBoot start (optional)
4Ch		Shadow video BIOS ROM

Code	Beeps	POST Routine Description
4Eh		Display BIOS copyright notice
50h		Display CPU type and speed
51h		Initialize EISA board
52h		Test keyboard
54h		Set key click if enabled
58h	2-2-3-1	Test for unexpected interrupts
59h		Initialize POST display service
5Ah		Display prompt "Press F2 to enter SETUP"
5Bh		Disable CPU cache
5Ch		Test RAM between 512 and 640 KB
60h		Test extended memory
62h		Test extended memory address lines
64h		Jump to UserPatch1
66h		Configure advanced cache registers
67h		Initialize Multi Processor APIC
68h		Enable external and CPU caches
69h		Setup System Management Mode (SMM) area
6Ah		Display external L2 cache size
6Bh		Load custom defaults (optional)
6Ch		Display shadow-area message
6Eh		Display possible high address for UMB recovery
70h		Display error messages
72h		Check for configuration errors
76h		Check for keyboard errors
7Ch		Set up hardware interrupt vectors
7Eh		Initialize coprocessor if present
80h		Disable onboard Super USB ports and IRQs
81h		Late POST device initialization
82h		Detect and install external RS232 ports

Code	Beeps	POST Routine Description
83h		Configure non-MCD IDE controllers
84h		Detect and install external parallel ports
85h		Initialize PC-compatible PnP ISA devices
86h		Re-initialize onboard USB ports.
87h		Configure Motheboard Configurable Devices (optional)
88h		Initialize BIOS Data Area
89h		Enable Non-Maskable Interrupts (NMIs)
8Ah		Initialize Extended BIOS Data Area
8Bh		Test and initialize PS/2 mouse
8Ch		Initialize floppy controller

Code	Beeps	POST Routine Description
8Fh		Determine number of ATA drives (optional)
90h		Initialize hard-disk controllers
91h		Initialize local-bus hard-disk controllers
92h		Jump to UserPatch2
93h		Build MPTABLE for multi-processor boards
95h		Install CD ROM for boot
96h		Clear huge ES segment register
97h		Fixup Multi Processor table
98h	1-2	Search for option ROMs. One long, two short beeps on checksum failure
99h		Check for SMART Drive (optional)
9Ah		Shadow option ROMs
9Ch		Set up Power Management
9Dh		Initialize security engine (optional)
9Eh		Enable hardware interrupts
9Fh		Determine number of ATA and SCSI drives
A0h		Set time of day
A2h		Check key lock
A4h		Initialize Typematic rate
A8h		Erase F2 prompt
AAh		Scan for F2 key stroke
ACh		Enter SETUP
A Eh		Clear Boot flag
B0h		Check for errors
B2h		POST done - prepare to boot operating system
B4h	1	One short beep before boot
B5h		Terminate QuietBoot (optional)
B6h		Check password (optional)
B9h		Prepare Boot
BAh		Initialize DMI parameters
BBh		Initialize PnP Option ROMs
BCh		Clear parity checkers

Code	Beeps	POST Routine Description
BDh		Display MultiBoot menu
BEh		Clear screen (optional)
BFh		Check virus and backup reminders
C0h		Try to boot with INT 19
C1h		Initialize POST Error Manager (PEM)
C2h		Initialize error logging
C3h		Initialize error display function

Code	Beeps	POST Routine Description
C4h		Initialize system error handler
C5h		PnPnd dual CMOS (optional)
C6h		Initialize notebook docking (optional)
C7h		Initialize notebook docking late
C8h		Force check (optional)
C9h		Extended checksum (optional)
D2h		Unknown interrupt

Code	Beeps	For Boot Block in Flash ROM
E0h		Initialize the chipset
E1h		Initialize the bridge
E2h		Initialize the CPU
E3h		Initialize system timer
E4h		Initialize system USB
E5h		Check force recovery boot
E6h		Checksum BIOS ROM
E7h		Go to BIOS
E8h		Set Huge Segment
E9h		Initialize Multi Processor
EAh		Initialize OEM special code
EBh		Initialize PIC and DMA
ECh		Initialize Memory type
EDh		Initialize Memory size
EEh		Shadow Boot Block
EFh		System memory test
F0h		Initialize interrupt vectors
F1h		Initialize Run Time Clock
F2h		Initialize video
F3h		Initialize System Management Mode
F4h	1	Output one beep before boot
F5h		Boot to Mini DOS
F6h		Clear Huge Segment
F7h		Boot to Full DOS

Jumper and Connector Locations

Mainboard Top View

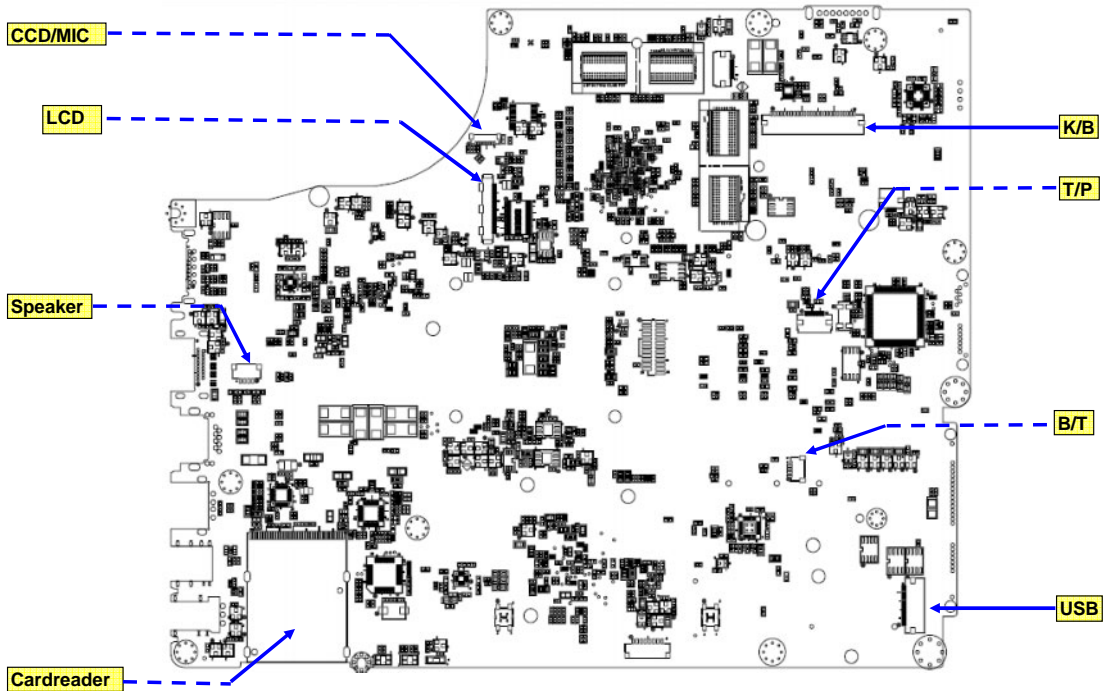

Mainboard Bottom View

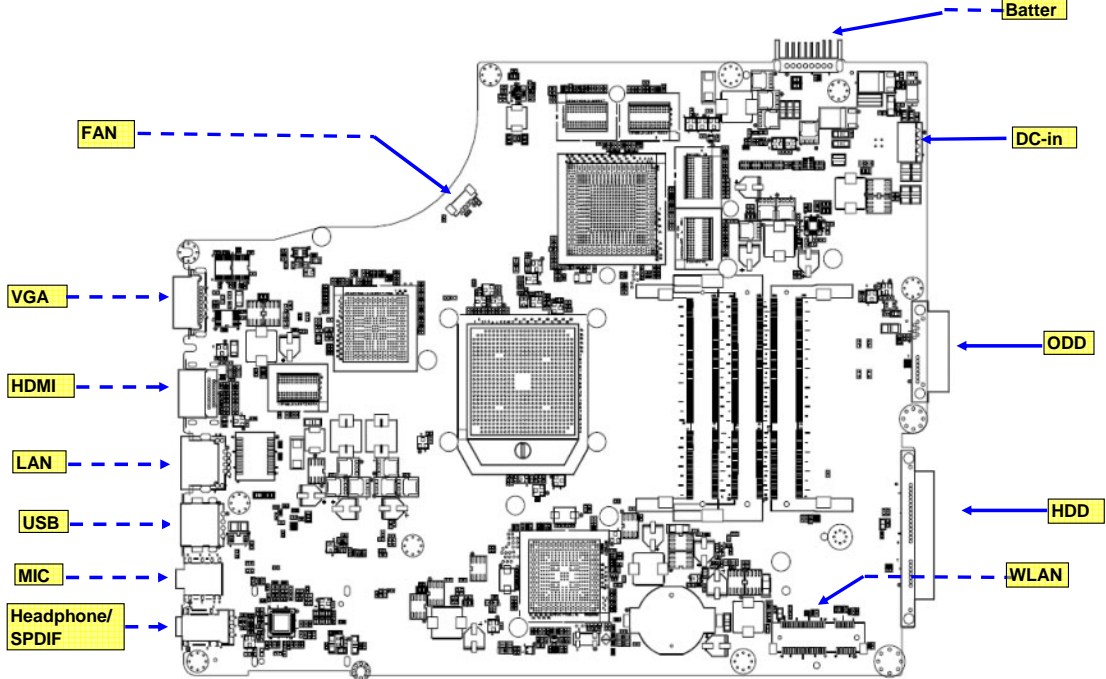

BIOS Recovery

BIOS Recovery by Crisis Disk

BIOS Recovery Boot Block

The BIOS Recovery Boot Block is a special block of BIOS. It is used to boot up the system with minimum BIOS initialization. Users can enable this feature to restore the BIOS firmware to the factory settings if a BIOS flash process fails.

BIOS Recovery Hotkey

The system provides a function hotkey: **Fn+Esc**, to enable the BIOS Recovery process when a system is powered on during BIOS POST. To use this function, it is strongly recommended to have the AC adapter and Battery present. If this function is enabled, the system will force the BIOS to enter a special BIOS block, called Boot Block.

Steps for BIOS Recovery from USB Storage

Before performing this procedure, prepare a Crisis USB key. The Crisis USB key can be made by executing the Crisis Disk program in a functioning system with a Windows 7 OS.

IMPORTANT:The Crisis Disk program will overwrite all data on any drive that you use as a crisis disk.

Follow the steps below:

1. Modify the archive name from "zh7 bios" to "ZH7X64.fd"
2. Save ROM file (file name: **ZH7X64.fd**) to the root directory of the USB storage.
3. Plug the USB storage into a USB port.
4. Press **Fn + ESC** button then plug in AC.
The Power button flashes once.
5. Press **Power** button to initiate system CRISIS mode.
When CRISIS is complete, the system auto restarts with a workable BIOS.
6. Update the latest version BIOS for this machine by the regular BIOS flashing process.

FRU (Field Replaceable Unit) List

This chapter gives you the FRU (Field Replaceable Unit) listing in global configurations of the computer. Refer to this chapter whenever ordering for parts to repair or for RMA (Return Merchandise Authorization).

Please note that WHEN ORDERING FRU PARTS, you should check the most up-to-date information available on your regional web or channel. For whatever reasons a part number change is made, it will not be noted on the printed Service Guide. For ACER AUTHORIZED SERVICE PROVIDERS, your Acer office may have a DIFFERENT part number code from those given in the FRU list of this printed Service Guide. You MUST use the local FRU list provided by your regional Acer office to order FRU parts for repair and service of customer machines.

NOTE: To scrap or to return the defective parts, you should follow the local government ordinance or regulations on how to dispose it properly, or follow the rules set by your regional Acer office on how to return it.

Exploded Diagrams

Main Assembly

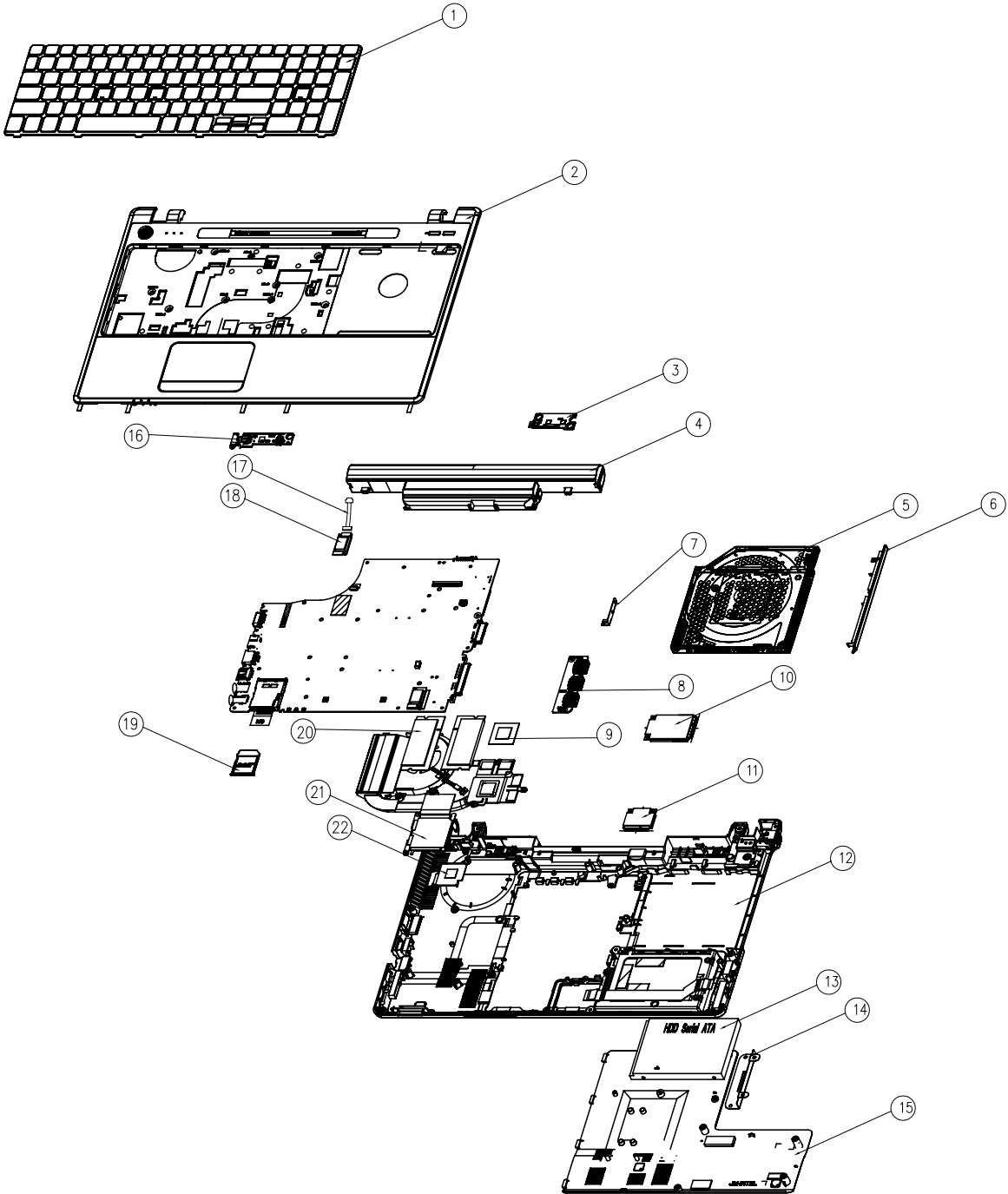

Item	Description	Part Number
1	Keyboard	KB.I170A.172
2	Top Cover	60.PTN07.002
3	Function Board	55.PU407.003
4	Battery	BT.00606.009
5	DVD/RW	6M.PU407.001
6	ODD Bezel	42.PSR07.003

Item	Description	Part Number
7	ODD Bracket	33.PTN07.001
8	USB Board	55.PU407.002
9	CPU	KC.33001.DMP
10	WWAN Card	LC.21300.008
11	WLAN Card	NI.23600.047
12	Lower Cover	60.PTW07.001
13	HDD	KH.16008.027
14	HDD Bracket	33.EDM07.001
15	Base Door	42.PU407.001
16	Power Board	55.PU407.001
17	Bluetooth Cable	50.PTN07.001
18	Bluetooth Module	BH.21100.004
19	Dummy Card	42.PSR07.002
20	DDR3 DIMM	KN.1GB09.012
21	Thermal Module	60.PU407.003
22	PCH Heat Sink	60.PTN07.008

NOTE: Part numbers may be different depending on your model. Please refer to the FRU List for a full listing of part numbers.

LCD Assembly

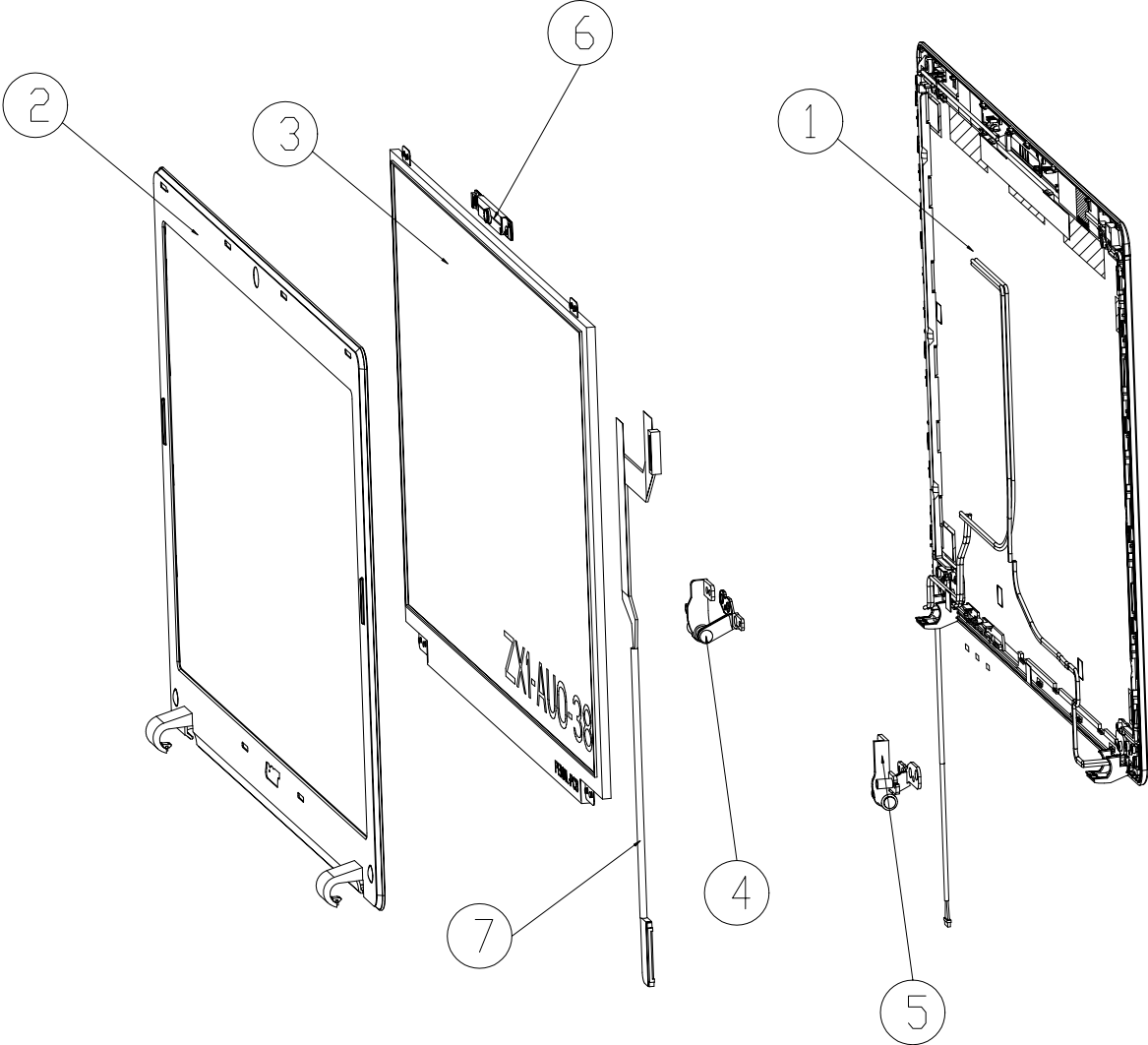







Item	Description	Part Number
1	LCD Cover	60.PU407.002
2	LCD Bezel	60.PTN07.005
3	LCD Panel	LK.15606.008
4	LCD Hinge Left	33.PTN07.002
5	LCD Hinge Right	33.PTN07.003
6	Camera	AM.21400.068
7	Cable Assembly	50.PTN07.002



NOTE: Part numbers may be different depending on your model. Please refer to the FRU List for a full listing of part numbers.







FRU List

CATEGORY	PARTNAME	ACER PART NO.
ADAPTER		
	Adapter DELTA 65W 19V 1.7x5.5x11 Yellow ADP-65JH DB A, LV5 LED LF	AP.06501.026
	Adapter LITE-ON 65W 19V 1.7x5.5x11 Yellow PA-1650-22AC LV5 LED LF	AP.06503.024
	Adapter HIPRO 65W 19V 1.7x5.5x11 Yellow HP-A0652R3B 1LF, LV5 LED LF	AP.0650A.012
	Adapter DELTA 65W 19V 1.7x5.5x11 Yellow ADP-65VH BA, LV5, Low profile LED LF	AP.06501.033
	Adapter Chicony Power 65W 19V 1.7x5.5x11 Yellow CPA09-A065N1, LV5, low profile LED LF	AP.0650A.017
	Adapter DELTA 90W 19V 1.7x5.5x11 Blue ADP-90CD DB A, LV5 LED LF	AP.09001.027
	Adapter LITE-ON 90W 19V 1.7x5.5x11 Blue PA-1900-34AR, LV5 LED LF	AP.09003.021
	Adapter HIPRO 90W 19V 1.7x5.5x11 Blue HP-A0904A3 B1LF, LV5 LED LF	AP.0900A.005
BATTERY		
	Battery PANASONIC AS10B Li-Ion 3S2P PANASONIC 6 cell 6000mAh Main COMMON ID:AS10B5E	BT.00605.063
	Battery SAMSUNG AS10B Li-Ion 3S2P SAMSUNG 6 cell 6000mAh Main COMMON ID:AS10B6E	BT.00606.009
	Battery SIMPLO AS10B Li-Ion 3S2P SAMSUNG 6 cell 6000mAh Main COMMON ID:AS10B7E	BT.00607.128
	Battery SIMPLO AS10E Li-Ion 3S3P SAMSUNG 9 cell 9000mAh Main COMMON ID:AS10E7E	BT.00907.013
BOARD		
	Foxconn Wireless LAN Atheros HB93 2x2 BGN (HM)	NI.23600.062
	Foxconn Wireless LAN Broadcomm 43225 2x2 BGN (HM) T77H103.00	NI.23600.066
	Foxconn Wireless LAN Atheros HB97 2x2 BGN (HM)	NI.23600.072
	Foxconn Wirelss LAN Atheros HB95BG (HM) T77H121.10	NI.23600.077
	Foxconn Bluetooth FOX BRM 2046 BT2.1	BH.21100.004
	Foxconn Bluetooth ATH AR3011	BH.21100.005
	POWER BOARD	55.PV707.001
	USB BOARD	55.PV707.002
	FUNCTION BOARD	55.PV707.003

CATEGORY	PARTNAME	ACER PART NO.
CABLE		
	PWR CORD V943B30001218008 DANISH 3P	27.A03V7.006
	PWR CORD(ISR)1.8M 3PBLK FZ0I0008-038	27.TATV7.005
	PWR CORD V50CB3T3012180QD TW-110V,3P	27.A99V7.002
	POWER CORD(SWI)1.8M 3PBLACK FZ0I0008-011	27.A99V7.004
	POWER CORD(IT) 1.8M 3PBLACK FZ0I0008-008	27.A99V7.005
	POWER CORD(S.A) 1.8M 3BLACK FZ0I0008-006	27.T48V7.001
	POWER CORD US 3PIN ROHS	27.TAXV7.001
	POWER CORD(EU) 1.8M 3PBLACK FM0I0008-010	27.TATV7.001
	POWER CORD BRAZIL IMETRO 3 PIN	27.S0607.001
	POWER CORD UK 3PIN	27.A03V7.004
	POWER CORD ITALIAN 3PIN	27.A99V7.005
	POWER CORD PRC 3P Y536B30001218008	27.TATV7.004
	POWER CORD AU W/LABEL (3 PIN)	27.A50V7.003
	BLUETOOTH CABLE	50.PTN07.001
CASE/COVER/BRACKET ASSEMBLY		
	UPPER CASE ASSY W/TP,FFC*3,W/SPK QMI	60.PV707.001
	LOWER CASE ASSY W/USB FFC, DC IN FOR UMA 65W	60.PV707.002
	LOWER CASE ASSY W/USB FFC, DC IN FOR DIS 90W	60.PV707.003
	RAM DOOR	42.PV707.001
	DUMMY CARD	42.PSR07.002
CPU/PROCESSOR		
	CPU AMD AthlonII N330 2.3G 1M 35W Dual-Core	KC.AN002.330
	CPU AMD TurionII N530 2.5G 2M 35W Dual-Core	KC.TN002.530
	CPU AMD PhenomII N830 2.1G 35W 1.5M L2, Triple-Core	KC.PN002.830
	CPU AMD PhenomII N930 2.0G 2M 35W Quad-Core	KC.PN002.930
	CPU AMD PhenomII P820 1.8G 25W 1.5M L2, Triple-Core	KC.PP002.820
	CPU AMD PhenomII P920 1.6G 2M 25W Quad-Core	KC.PP002.920
	CPU AMD AthlonII P320 2.1G 1M 25W Dual-Core	KC.AP002.320
	CPU AMD TurionII P520 2.3G 2M 25W Dual-Core	KC.TP002.520

CATEGORY	PARTNAME	ACER PART NO.
DVD RW DRIVE		
	DVD/RW SUPER MULTI 9.5MM MODULE	6M.PTN07.001
	ODD TOSHIBA Super-Multi DRIVE 9.5mm Tray DL 8X TS-U633F LF W/O bezel SATA (HF + Windows 7)	KU.00801.034
	ODD PANASONIC Super-Multi DRIVE 9.5mm Tray DL 8X UJ892 LF W/O bezel SATA GBAS2.0, (HF + Windows7)	KU.00807.068
	ODD HLDS Super-Multi DRIVE 9.5mm Tray DL 8X GU10N LF W/O bezel SATA (HF + Windows 7)	KU.0080D.049
	ODD BEZEL - 9.5mm SUPER MULTI	42.PSN07.002
	ODD BRACKET SLIM 9.5mm	33.PTN07.001
HDD/HARD DISK DRIVE		
	HDD WD 2.5" 5400rpm 160GB WD1600BEVT-22A23T0 , WD, ML320S SATA 8MB LF F/W:01.01A01	KH.16008.027
	HDD SEAGATE 2.5" 5400rpm 160GB ST9160314AS Wyatt SATA LF F/W:0001SDM1	KH.16001.042
	HDD TOSHIBA 2.5" 5400rpm 160GB MK1665GSX, Capricorn BS, 320G/P SATA 8MB LF F/W:GJ001J	KH.16004.008
	HDD HGST 2.5" 5400rpm 160GB HTS545016B9A300 Panther B SATA LF F/W:C60F Disk imbalance criteria = 0.014g-cm	KH.16007.026
	HDD WD 2.5" 5400rpm 250GB WD2500BEVT-22A23T0, WD, ML320S SATA 8MB LF F/W:01.01A01.	KH.25008.025
	HDD SEAGATE 2.5" 5400rpm 250GB ST9250315AS Wyatt SATA LF F/W:0001SDM1	KH.25001.016
	HDD TOSHIBA 2.5" 5400rpm 250GB MK2565GSX, Capricorn BS, 320G/P SATA 8MB LF F/W:GJ001J	KH.25004.005
	HDD HGST 2.5" 5400rpm 250GB HTS545025B9A300 Panther B SATA LF F/W:C60F Disk imbalance criteria = 0.014g-cm	KH.25007.016
	HDD WD 2.5" 5400rpm 320GB WD3200BEVT-22A23T0,ML320S,WD SATA 8MB LF F/W:01.01A01	KH.32008.019
	HDD SEAGATE 2.5" 5400rpm 320GB ST9320325AS Wyatt SATA LF F/W:0001SDM1	KH.32001.017
	HDD TOSHIBA 2.5" 5400rpm 320GB Capricorn BS ,MK3265GSX SATA 8MB LF F/W:GJ001J	KH.32004.004
	HDD HGST 2.5" 5400rpm 320GB HTS545032B9A300 Panther B SATA LF F/W:C60F Disk imbalance criteria = 0.014g-cm	KH.32007.008
	HDD WD 2.5" 5400rpm 500GB WD5000BEVT-22A0RT0, ML320M,WD SATA 8MB LF F/W:01.01A01	KH.50008.017
	HDD SEAGATE 2.5" 5400rpm 500GB ST9500325AS Wyatt SATA LF F/W:0001SDM1	KH.50001.011
HDD TOSHIBA 2.5" 5400rpm 500GB MK5065GSX,Capricorn BS, 320G/P SATA 8MB LF F/W:GJ001J	KH.50004.002	

CATEGORY	PARTNAME	ACER PART NO.
	HDD HGST 2.5" 5400rpm 500GB HTS545050B9A300 Panther B SATA LF F/W:C60F Disk imbalance criteria = 0.014g-cm	KH.50007.010
	HDD WD 2.5" 5400rpm 640GB WD6400BEVT-22A0RT0, ML320 SATA 8MB LF F/W:01.01A01	KH.64008.004
	HDD BRACKET	33.EDM07.001
KEYBOARD		
	Keyboard ACER AC7T_A10B AC7T Internal 17 Standard 103KS Black US International Texture	KB.I170A.172
	Keyboard ACER AC7T_A10B AC7T Internal 17 Standard 103KS Black Chinese Texture	KB.I170A.151
	Keyboard ACER AC7T_A10B AC7T Internal 17 Standard 103KS Black Greek Texture	KB.I170A.156
	Keyboard ACER AC7T_A10B AC7T Internal 17 Standard 103KS Black Thailand Texture	KB.I170A.169
	Keyboard ACER AC7T_A10B AC7T Internal 17 Standard 104KS Black SLO/CRO Texture	KB.I170A.165
	Keyboard ACER AC7T_A10B AC7T Internal 17 Standard 104KS Black CZ/SK Texture	KB.I170A.150
	Keyboard ACER AC7T_A10B AC7T Internal 17 Standard 104KS Black Hungarian Texture	KB.I170A.157
	Keyboard ACER AC7T_A10B AC7T Internal 17 Standard 104KS Black Brazilian Portuguese Texture	KB.I170A.149
	Keyboard ACER AC7T_A10B AC7T Internal 17 Standard 103KS Black Russian Texture	KB.I170A.164
	Keyboard ACER AC7T_A10B AC7T Internal 17 Standard 104KS Black Turkish Texture	KB.I170A.170
	Keyboard ACER AC7T_A10B AC7T Internal 17 Standard 104KS Black Belgium Texture	KB.I170A.148
	Keyboard ACER AC7T_A10B AC7T Internal 17 Standard 104KS Black Sweden Texture	KB.I170A.167
	Keyboard ACER AC7T_A10B AC7T Internal 17 Standard 104KS Black UK Texture	KB.I170A.171
	Keyboard ACER AC7T_A10B AC7T Internal 17 Standard 104KS Black French Texture	KB.I170A.154
	Keyboard ACER AC7T_A10B AC7T Internal 17 Standard 104KS Black German Texture	KB.I170A.155
	Keyboard ACER AC7T_A10B AC7T Internal 17 Standard 104KS Black Italian Texture	KB.I170A.158
	Keyboard ACER AC7T_A10B AC7T Internal 17 Standard 107KS Black Japanese Texture	KB.I170A.159
	Keyboard ACER AC7T_A10B AC7T Internal 17 Standard 104KS Black US w/ Canadian French Texture	KB.I170A.174
	Keyboard ACER AC7T_A10B AC7T Internal 17 Standard 104KS Black Danish Texture	KB.I170A.152
	Keyboard ACER AC7T_A10B AC7T Internal 17 Standard 104KS Black Nordic Texture	KB.I170A.161

CATEGORY	PARTNAME	ACER PART NO.
	Keyboard ACER AC7T_A10B AC7T Internal 17 Standard 104KS Black Spanish Texture	KB.I170A.166
	Keyboard ACER AC7T_A10B AC7T Internal 17 Standard 103KS Black Arabic Texture	KB.I170A.147
	Keyboard ACER AC7T_A10B AC7T Internal 17 Standard 104KS Black FR/Arabic Texture	KB.I170A.153
	Keyboard ACER AC7T_A10B AC7T Internal 17 Standard 104KS Black Swiss/G Texture	KB.I170A.168
	Keyboard ACER AC7T_A10B AC7T Internal 17 Standard 104KS Black Portuguese Texture	KB.I170A.163
	Keyboard ACER AC7T_A10B AC7T Internal 17 Standard 103KS Black US International w/ Hebrew Texture	KB.I170A.173
	Keyboard ACER AC7T_A10B AC7T Internal 17 Standard 104KS Black Norwegian Texture	KB.I170A.162
	Keyboard ACER AC7T_A10B AC7T Internal 17 Standard 103KS Black Korean Texture	KB.I170A.160
LCD Module		
	LCD MODULE ASSY LED AL W/ANTENNA*2 FOR NON-3G	6M.PTN07.005
	LED LCD SAMSUNG 15.6"W WXGA Glare LTN156AT11-A01 LF 200nit 16ms 500:1 (Power saving)	LK.15606.008
	LED LCD LPL 15.6"W WXGA Glare LP156WH3-TLL1 LF 200nit 16ms 500:1 (Power saving)	LK.15608.008
	LED LCD AUO 15.6"W WXGA Glare B156XW04 V0 LF 200nit 8ms 400:1 (Power saving)	LK.15605.015
	LCD COVER ASSY AL W/MIC CCD CABLE ANTENNA*3 FOR NON 3G	60.PTN07.006
	LCD BEZEL ASSY FOR CCD W/RUBBER W/LOGO	60.PTN07.005
	LCD HINGE - L	33.PTN07.002
	LCD HINGE - R	33.PTN07.003
	LCD CABLE	50.PTN07.002
Camera		
	Suyin 1.3M SY9665SN	AM.21400.068
	Chicony 1.3M CH9665SN (CNF9157)	AM.21400.067

CATEGORY	PARTNAME	ACER PART NO.
	Liteon 1.3M LT9665AL (09P2SF119)	AM.21400.069
	Liteon 1.3M LT6AASP(09P2BF127)	AM.21400.070
MEMORY		
	Memory ELPIDA SO-DIMM DDRIII 1066 1GB EBJ10UE8BDS0-AE-F LF 128*8 0.065um	KN.1GB09.012
	Memory SAMSUNG SO-DIMM DDRIII 1066 1GB M471B2873EH1-CF8 LF 64*16 0.055um	KN.1GB0B.028
	Memory HYNIX SO-DIMM DDRIII 1066 1GB HMT112S6BFR6C-G7 N0 LF 64*16 0.055um	KN.1GB0G.025
	Memory ELPIDA SO-DIMM DDRIII 1333 1GB EBJ10UE8BDS0-DJ-F LF 128*8 0.065um	KN.1GB09.015
	Memory SAMSUNG SO-DIMM DDRIII 1333 1GB M471B2873FHS-CH9 LF 128*8 46nm	KN.1GB0B.035
	Memory ELPIDA SO-DIMM DDRIII 1066 2GB EBJ21UE8BDS0-AE-F LF 128*8 0.065um	KN.2GB09.006
	Memory SAMSUNG SO-DIMM DDRIII 1066 2GB M471B5673EH1-CF8 LF 128*8 0.055um	KN.2GB0B.012
	Memory HYNIX SO-DIMM DDRIII 1066 2GB HMT125S6BFR8C-G7 N0 LF 128*8 0.055um	KN.2GB0G.014
	Memory ELPIDA SO-DIMM DDRIII 1333 2GB EBJ21UE8BDS0-DJ-F LF 128*8 0.065um	KN.2GB09.007
	Memory ELPIDA SO-DIMM DDRIII 1333 4GB EBJ41UF8BAS0-DJ-F LF 256*8 0.055um	KN.4GB09.001
	Memory SAMSUNG SO-DIMM DDRIII 1333 4GB M471B5273CH0-CH9 LF 256*8 46nm	KN.4GB0B.010
	Memory NANYA SO-DIMM DDRIII 1333 2GB NT2GC64B8HC0NS-CG LF 128*8 0.065um	KN.2GB03.017
	MAINBOARD	
	MAIN BOARD UMA RS880+SB820 W/SIDE-PORT VRAM CARD READER W/O CPU	MB.PV606.001
	MAIN BOARD MADISON_PRO1GB RS880+SB820 W/ SIDE-PORT VRAM CARD READER W/O CPU	MB.PV706.001
	MAIN BOARD PARK_XT512 RS880+SB820 W/SIDE- PORT VRAM CARD READER W/O CPU	MB.PU806.001
HEATSINK		
	THERMAL MODULE FOR 35W UMA	60.PV707.004
	THERMAL MODULE FOR 35W DIS	60.PV707.005
	HEAT SINK PCH	60.PV707.006
SPEAKER		
	SPEAKER MODULE (WITH L/R)QMI	23.PTN07.002
MISCELLANEOUS		
	BASE RUBBER - FRONT (SQUARE)	47.PU407.001
	BASE RUBBER (SQUARE)	47.PU407.002
	BASE RUBBER - REAR (RECTANGLE)	47.PU407.003
	LCD RUBBER - TOP & BOTTOM SIDE	47.PU407.004
	LCD RUBBER - R & L SIDE	47.PU407.005
	TOP COVER RUBBER (RECTANGLE)	47.PU407.006

CATEGORY	PARTNAME	ACER PART NO.
SCREW		
	SCREW M2.5*4.0-I(BUWZN)(NYLON PATCH)IRON	86.EDM07.003
	SCREW M2.5*5-I(BNI)(NYLOK)	86.A03V7.003
	SCREW M2.5*2-I (NI,NYLOK)IRON	86.EDM07.002
	SCREW M2.0*3.0-I-NI-NYLOK	86.A08V7.005
	SCREW M3*0.5+3.5I	86.N1407.007
	SCREW M2.5*2.5-I(BNI)(NYLOK) IRON	86.PTN07.001
	SCREW M2.5*6.2-I(NI)(NYLOK)IRON	86.PTN07.002

Model Definition and Configuration

Model	RO	Country	Acer Part No	Description
AS5625G-P924G50Mn	EMEA	Germany	LX.PV702.097	AS5625G-P924G50Mn W7HP64ATDE1 MC MADISON_PRO1GBCks_3V3 2*2G/ 500_L/BT/6L3.0/5R/ CB_bgn_1.3C_AL_DE11
AS5625G-P824G50Mn	WW	WW	S2.PV702.001	AS5625G-P824G50Mn W7HP64AWW1 MC MADISON_PRO1GBCks_3 2*2G/ 500_L/BT/6L3.0/5R/ CB_bgn_1.3C_AL_ES62
AS5625G-P924G50Mn	EMEA	Middle East	LX.PV702.096	AS5625G-P924G50Mn EM W7HP64EMATMEB MC MADISON_PRO1GBCks_3V3 2*2G/500_L/ 6L3.0/5R/CB_bgn_1.3C_AL_ARA1
AS5625G-P924G50Mn	EMEA	Middle East	LX.PV702.095	AS5625G-P924G50Mn EM W7HP64EMATME2 MC MADISON_PRO1GBCks_3V3 2*2G/500_L/ 6L3.0/5R/CB_bgn_1.3C_AL_AR21
AS5625G-P924G50Mn	EMEA	South Africa	LX.PV702.094	AS5625G-P924G50Mn EM W7HP64EMATZA5 MC MADISON_PRO1GBCks_3V3 2*2G/500_L/ 6L3.0/5R/CB_bgn_1.3C_AL_ES61
AS5625G-P924G50Mn	EMEA	Ukraine	LX.PV702.093	AS5625G-P924G50Mn W7HP64RUATUK1 MC MADISON_PRO1GBCks_3V3 2*2G/ 500_L/6L3.0/5R/CB_bgn_1.3C_AL_RU61
AS5625G-P924G50Mi	EMEA	Russia	LX.PV702.092	AS5625G-P924G50Mi W7HP64RUATRU1 MC MADISON_PRO1GBCks_3V3 2*2G/ 500_L/6L3.0/5R/CB_bg_1.3C_AL_RU11
AS5625G-P924G50Mn	EMEA	Middle East	LX.PV702.091	AS5625G-P924G50Mn EM W7HP64EMATME4 MC MADISON_PRO1GBCks_3V3 2*2G/500_L/ 6L3.0/5R/CB_bgn_1.3C_AL_RU61
AS5625G-P924G50Mn	EMEA	Middle East	LX.PV702.090	AS5625G-P924G50Mn EM W7HP64EMATME2 MC MADISON_PRO1GBCks_3V3 2*2G/500_L/ 6L3.0/5R/CB_bgn_1.3C_AL_ES61
AS5625G-P924G50Mn	EMEA	South Africa	LX.PV702.089	AS5625G-P924G50Mn EM W7HP64EMATZA2 MC MADISON_PRO1GBCks_3V3 2*2G/500_L/ 6L3.0/5R/CB_bgn_1.3C_AL_ES61
AS5625G-P924G50Mn	EMEA	Turkey	LX.PV702.088	AS5625G-P924G50Mn EM W7HP64EMATTR1 MC MADISON_PRO1GBCks_3V3 2*2G/500_L/ 6L3.0/5R/CB_bgn_1.3C_AL_TR31
AS5625G-P924G50Mn	EMEA	Middle East	LX.PV702.087	AS5625G-P924G50Mn EM W7HP64EMATME9 MC MADISON_PRO1GBCks_3V3 2*2G/500_L/ 6L3.0/5R/CB_bgn_1.3C_AL_ES81

Model	RO	Country	Acer Part No	Description
AS5625G-P924G50Mn	EMEA	Algeria	LX.PV702.086	AS5625G-P924G50Mn EM W7HP64EMATDZ1 MC MADISON_PRO1GBCKs_3V3 2*2G/500_L/ 6L3.0/5R/CB_bgn_1.3C_AL_ES81
AS5625G-P924G50Mn	EMEA	South Africa	LX.PV702.085	AS5625G-P924G50Mn EM W7HP64EMATZA1 MC MADISON_PRO1GBCKs_3V3 2*2G/500_L/ 6L3.0/5R/CB_bgn_1.3C_AL_ES81
AS5625G-P924G50Mn	EMEA	Middle East	LX.PV702.084	AS5625G-P924G50Mn EM W7HP64EMATME4 MC MADISON_PRO1GBCKs_3V3 2*2G/500_L/ 6L3.0/5R/CB_bgn_1.3C_AL_ES61
AS5625G-P924G50Mn	EMEA	Middle East	LX.PV702.083	AS5625G-P924G50Mn EM W7HP64EMATME2 MC MADISON_PRO1GBCKs_3V3 2*2G/500_L/ 6L3.0/5R/CB_bgn_1.3C_AL_AR11
AS5625G-P924G50Mn	EMEA	Middle East	LX.PV702.082	AS5625G-P924G50Mn EM W7HP64EMATME3 MC MADISON_PRO1GBCKs_3V3 2*2G/500_L/ 6L3.0/5R/CB_bgn_1.3C_AL_ES81
AS5625G-P924G50Mn	EMEA	Middle East	LX.PV702.081	AS5625G-P924G50Mn EM W7HP64EMATME6 MC MADISON_PRO1GBCKs_3V3 2*2G/500_L/ 6L3.0/5R/CB_bgn_1.3C_AL_ES61
AS5625G-P924G50Mn	EMEA	South Africa	LX.PV702.080	AS5625G-P924G50Mn EM W7HP64EMATZA4 MC MADISON_PRO1GBCKs_3V3 2*2G/500_L/ 6L3.0/5R/CB_bgn_1.3C_AL_ES61
AS5625G-P924G50Mn	EMEA	Germany	LX.PV702.079	AS5625G-P924G50Mn W7HP64ATDE1 MC MADISON_PRO1GBCKs_3V3 2*2G/ 500_L/6L3.0/5R/CB_bgn_1.3C_AL_DE11
AS5625G-P924G50Mn	EMEA	Poland	LX.PV702.078	AS5625G-P924G50Mn W7HP64ATPL1 MC MADISON_PRO1GBCKs_3V3 2*2G/500_L/ 6L3.0/5R/CB_bgn_1.3C_AL_PL11
AS5625G-P924G50Mn	EMEA	Baltic	LX.PV702.077	AS5625G-P924G50Mn W7HP64ATBC5 MC MADISON_PRO1GBCKs_3V3 2*2G/ 500_L/6L3.0/5R/CB_bgn_1.3C_AL_LT11
AS5625G-P924G50Mn	EMEA	Holland	LX.PV702.076	AS5625G-P924G50Mn W7HP64ATNL1 MC MADISON_PRO1GBCKs_3V3 2*2G/ 500_L/6L3.0/5R/CB_bgn_1.3C_AL_NL11
AS5625G-P924G50Mn	EMEA	Belgium	LX.PV702.075	AS5625G-P924G50Mn W7HP64ATBE1 MC MADISON_PRO1GBCKs_3V3 2*2G/ 500_L/6L3.0/5R/CB_bgn_1.3C_AL_NL11
AS5625G-P924G50Mn	EMEA	Switzerland	LX.PV702.074	AS5625G-P924G50Mn W7HP64ATCH1 MC MADISON_PRO1GBCKs_3V3 2*2G/ 500_L/6L3.0/5R/CB_bgn_1.3C_AL_IT41
AS5625G-P924G50Mn	EMEA	Luxembourg	LX.PV702.073	AS5625G-P924G50Mn W7HP64ATLU3 MC MADISON_PRO1GBCKs_3V3 2*2G/ 500_L/6L3.0/5R/CB_bgn_1.3C_AL_IT41
AS5625G-P924G50Mn	EMEA	Latvia	LX.PV702.072	AS5625G-P924G50Mn W7HP64ATLV1 MC MADISON_PRO1GBCKs_3V3 2*2G/500_L/ 6L3.0/5R/CB_bgn_1.3C_AL_LT11

Model	RO	Country	Acer Part No	Description
AS5625G-P924G50Mn	EMEA	Latvia	LX.PV702.071	AS5625G-P924G50Mn W7HP64ATLV1 MC MADISON_PRO1GBCks_3V3 2*2G/500_L/6L3.0/5R/CB_bgn_1.3C_AL_RU22
AS5625G-P924G50Mn	EMEA	UK	LX.PV702.070	AS5625G-P924G50Mn W7HP64ATGB1 MC MADISON_PRO1GBCks_3V3 2*2G/500_L/6L3.0/5R/CB_bgn_1.3C_AL_EN11
AS5625G-P924G50Mn	EMEA	Eastern Europe	LX.PV702.069	AS5625G-P924G50Mn W7HP64ATEU5 MC MADISON_PRO1GBCks_3V3 2*2G/500_L/6L3.0/5R/CB_bgn_1.3C_AL_RO11
AS5625G-P924G50Mn	EMEA	Eastern Europe	LX.PV702.068	AS5625G-P924G50Mn W7HP64ATEU5 MC MADISON_PRO1GBCks_3V3 2*2G/500_L/6L3.0/5R/CB_bgn_1.3C_AL_PL71
AS5625G-P924G50Mn	EMEA	Czech	LX.PV702.067	AS5625G-P924G50Mn W7HP64ATCZ2 MC MADISON_PRO1GBCks_3V3 2*2G/500_L/6L3.0/5R/CB_bgn_1.3C_AL_SK11
AS5625G-P924G50Mn	EMEA	Hungary	LX.PV702.066	AS5625G-P924G50Mn W7HP64ATHU1 MC MADISON_PRO1GBCks_3V3 2*2G/500_L/6L3.0/5R/CB_bgn_1.3C_AL_HU11
AS5625G-P924G50Mn	EMEA	Israel	LX.PV702.065	AS5625G-P924G50Mn W7HP64ATIL1 MC MADISON_PRO1GBCks_3V3 2*2G/500_L/6L3.0/5R/CB_bgn_1.3C_AL_HE11
AS5625G-P924G50Mn	EMEA	Baltic	LX.PV702.064	AS5625G-P924G50Mn W7HP64ATBC4 MC MADISON_PRO1GBCks_3V3 2*2G/500_L/6L3.0/5R/CB_bgn_1.3C_AL_LT11
AS5625G-P924G50Mn	EMEA	Portugal	LX.PV702.063	AS5625G-P924G50Mn W7HP64ATPT1 MC MADISON_PRO1GBCks_3V3 2*2G/500_L/6L3.0/5R/CB_bgn_1.3C_AL_PT11
AS5625G-P924G50Mn	EMEA	Cyprus	LX.PV702.062	AS5625G-P924G50Mn W7HP64ATCY1 MC MADISON_PRO1GBCks_3V3 2*2G/500_L/6L3.0/5R/CB_bgn_1.3C_AL_ES61
AS5625G-P924G50Mn	EMEA	Baltic	LX.PV702.061	AS5625G-P924G50Mn W7HP64ATBC3 MC MADISON_PRO1GBCks_3V3 2*2G/500_L/6L3.0/5R/CB_bgn_1.3C_AL_SV21
AS5625G-P924G50Mn	EMEA	Serbia/Macedonia	LX.PV702.060	AS5625G-P924G50Mn W7HP64ATCS1 MC MADISON_PRO1GBCks_3V3 2*2G/500_L/6L3.0/5R/CB_bgn_1.3C_AL_SL11
AS5625G-P924G50Mn	EMEA	Italy	LX.PV702.059	AS5625G-P924G50Mn W7HP64ATIT1 MC MADISON_PRO1GBCks_3V3 2*2G/500_L/6L3.0/5R/CB_bgn_1.3C_AL_IT11
AS5625G-P924G50Mn	EMEA	Spain	LX.PV702.058	AS5625G-P924G50Mn W7HP64ATES1 MC MADISON_PRO1GBCks_3V3 2*2G/500_L/6L3.0/5R/CB_bgn_1.3C_AL_ES51
AS5625G-P924G50Mn	EMEA	Denmark	LX.PV702.057	AS5625G-P924G50Mn W7HP64ATDK2 MC MADISON_PRO1GBCks_3V3 2*2G/500_L/6L3.0/5R/CB_bgn_1.3C_AL_ENS1
AS5625G-P924G50Mn	EMEA	Eastern Europe	LX.PV702.056	AS5625G-P924G50Mn W7HP64ATEU7 MC MADISON_PRO1GBCks_3V3 2*2G/500_L/6L3.0/5R/CB_bgn_1.3C_AL_ENQ1
AS5625G-P924G50Mn	EMEA	Eastern Europe	LX.PV702.055	AS5625G-P924G50Mn W7HP64ATEU4 MC MADISON_PRO1GBCks_3V3 2*2G/500_L/6L3.0/5R/CB_bgn_1.3C_AL_SV21

Model	RO	Country	Acer Part No	Description
AS5625G-P924G50Mn	EMEA	Greece	LX.PV702.054	AS5625G-P924G50Mn W7HP64ATGR1 MC MADISON_PRO1GBCKs_3V3 2*2G/500_L/6L3.0/5R/CB_bgn_1.3C_AL_EL31
AS5625G-P924G50Mn	EMEA	Austria	LX.PV702.053	AS5625G-P924G50Mn W7HP64ATAT1 MC MADISON_PRO1GBCKs_3V3 2*2G/500_L/6L3.0/5R/CB_bgn_1.3C_AL_DE61
AS5625G-P924G50Mn	EMEA	France	LX.PV702.052	AS5625G-P924G50Mn W7HP64ATFR1 MC MADISON_PRO1GBCKs_3V3 2*2G/500_L/6L3.0/5R/CB_bgn_1.3C_AL_FR21
AS5625G-P924G50Mn	EMEA	Eastern Europe	LX.PV702.051	AS5625G-P924G50Mn W7HP64ATEU7 MC MADISON_PRO1GBCKs_3V3 2*2G/500_L/6L3.0/5R/CB_bgn_1.3C_AL_SL11
AS5625G-P824G32Mn	EMEA	Ukraine	LX.PV702.050	AS5625G-P824G32Mn W7HP64RUATUK1 MC MADISON_PRO1GBCKs_3V3 2*2G/320/6L3.0/5R/CB_bgn_1.3C_AL_RU61
AS5625G-P824G32Mi	EMEA	Russia	LX.PV702.049	AS5625G-P824G32Mi W7HP64RUATRU1 MC MADISON_PRO1GBCKs_3V3 2*2G/320/6L3.0/5R/CB_bg_1.3C_AL_RU11
AS5625G-P824G32Mn	EMEA	Middle East	LX.PV702.048	AS5625G-P824G32Mn EM W7HP64EMATME4 MC MADISON_PRO1GBCKs_3V3 2*2G/320/6L3.0/5R/CB_bgn_1.3C_AL_RU61
AS5625G-P824G32Mn	EMEA	Middle East	LX.PV702.047	AS5625G-P824G32Mn EM W7HP64EMATME2 MC MADISON_PRO1GBCKs_3V3 2*2G/320/6L3.0/5R/CB_bgn_1.3C_AL_ES61
AS5625G-P824G32Mn	EMEA	South Africa	LX.PV702.046	AS5625G-P824G32Mn EM W7HP64EMATZA2 MC MADISON_PRO1GBCKs_3V3 2*2G/320/6L3.0/5R/CB_bgn_1.3C_AL_ES61
AS5625G-P824G32Mn	EMEA	Turkey	LX.PV702.045	AS5625G-P824G32Mn EM W7HP64EMATTR1 MC MADISON_PRO1GBCKs_3V3 2*2G/320/6L3.0/5R/CB_bgn_1.3C_AL_TR31
AS5625G-P824G32Mn	EMEA	Middle East	LX.PV702.044	AS5625G-P824G32Mn EM W7HP64EMATMEB MC MADISON_PRO1GBCKs_3V3 2*2G/320/6L3.0/5R/CB_bgn_1.3C_AL_ARA1
AS5625G-P824G32Mn	EMEA	Middle East	LX.PV702.043	AS5625G-P824G32Mn EM W7HP64EMATME2 MC MADISON_PRO1GBCKs_3V3 2*2G/320/6L3.0/5R/CB_bgn_1.3C_AL_AR21
AS5625G-P824G32Mn	EMEA	South Africa	LX.PV702.042	AS5625G-P824G32Mn EM W7HP64EMATZA5 MC MADISON_PRO1GBCKs_3V3 2*2G/320/6L3.0/5R/CB_bgn_1.3C_AL_ES61
AS5625G-P824G32Mn	EMEA	Middle East	LX.PV702.041	AS5625G-P824G32Mn EM W7HP64EMATME9 MC MADISON_PRO1GBCKs_3V3 2*2G/320/6L3.0/5R/CB_bgn_1.3C_AL_ES81
AS5625G-P824G32Mn	EMEA	Algeria	LX.PV702.040	AS5625G-P824G32Mn EM W7HP64EMATDZ1 MC MADISON_PRO1GBCKs_3V3 2*2G/320/6L3.0/5R/CB_bgn_1.3C_AL_ES81

Model	RO	Country	Acer Part No	Description
AS5625G-P824G32Mn	EMEA	South Africa	LX.PV702.039	AS5625G-P824G32Mn EM W7HP64EMATZA1 MC MADISON_PRO1GBCKs_3V3 2*2G/320/6L3.0/5R/CB_bgn_1.3C_AL_ES81
AS5625G-P824G32Mn	EMEA	Middle East	LX.PV702.038	AS5625G-P824G32Mn EM W7HP64EMATME4 MC MADISON_PRO1GBCKs_3V3 2*2G/320/6L3.0/5R/CB_bgn_1.3C_AL_ES61
AS5625G-P824G32Mn	EMEA	Middle East	LX.PV702.037	AS5625G-P824G32Mn EM W7HP64EMATME2 MC MADISON_PRO1GBCKs_3V3 2*2G/320/6L3.0/5R/CB_bgn_1.3C_AL_AR11
AS5625G-P824G32Mn	EMEA	Middle East	LX.PV702.036	AS5625G-P824G32Mn EM W7HP64EMATME3 MC MADISON_PRO1GBCKs_3V3 2*2G/320/6L3.0/5R/CB_bgn_1.3C_AL_ES81
AS5625G-P824G32Mn	EMEA	Middle East	LX.PV702.035	AS5625G-P824G32Mn EM W7HP64EMATME6 MC MADISON_PRO1GBCKs_3V3 2*2G/320/6L3.0/5R/CB_bgn_1.3C_AL_ES61
AS5625G-P824G32Mn	EMEA	South Africa	LX.PV702.034	AS5625G-P824G32Mn EM W7HP64EMATZA4 MC MADISON_PRO1GBCKs_3V3 2*2G/320/6L3.0/5R/CB_bgn_1.3C_AL_ES61
AS5625G-P824G32Mn	EMEA	Germany	LX.PV702.033	AS5625G-P824G32Mn W7HP64ATDE1 MC MADISON_PRO1GBCKs_3V3 2*2G/320/6L3.0/5R/CB_bgn_1.3C_AL_DE11
AS5625G-P824G32Mn	EMEA	Poland	LX.PV702.032	AS5625G-P824G32Mn W7HP64ATPL1 MC MADISON_PRO1GBCKs_3V3 2*2G/320/6L3.0/5R/CB_bgn_1.3C_AL_PL11
AS5625G-P824G32Mn	EMEA	Baltic	LX.PV702.031	AS5625G-P824G32Mn W7HP64ATBC5 MC MADISON_PRO1GBCKs_3V3 2*2G/320/6L3.0/5R/CB_bgn_1.3C_AL_LT11
AS5625G-P824G32Mn	EMEA	Holland	LX.PV702.030	AS5625G-P824G32Mn W7HP64ATNL1 MC MADISON_PRO1GBCKs_3V3 2*2G/320/6L3.0/5R/CB_bgn_1.3C_AL_NL11
AS5625G-P824G32Mn	EMEA	Belgium	LX.PV702.029	AS5625G-P824G32Mn W7HP64ATBE1 MC MADISON_PRO1GBCKs_3V3 2*2G/320/6L3.0/5R/CB_bgn_1.3C_AL_NL11
AS5625G-P824G32Mn	EMEA	Switzerland	LX.PV702.028	AS5625G-P824G32Mn W7HP64ATCH1 MC MADISON_PRO1GBCKs_3V3 2*2G/320/6L3.0/5R/CB_bgn_1.3C_AL_IT41
AS5625G-P824G32Mn	EMEA	Luxembourg	LX.PV702.027	AS5625G-P824G32Mn W7HP64ATLU3 MC MADISON_PRO1GBCKs_3V3 2*2G/320/6L3.0/5R/CB_bgn_1.3C_AL_IT41
AS5625G-P824G32Mn	EMEA	Latvia	LX.PV702.026	AS5625G-P824G32Mn W7HP64ATLV1 MC MADISON_PRO1GBCKs_3V3 2*2G/320/6L3.0/5R/CB_bgn_1.3C_AL_LT11
AS5625G-P824G32Mn	EMEA	Latvia	LX.PV702.025	AS5625G-P824G32Mn W7HP64ATLV1 MC MADISON_PRO1GBCKs_3V3 2*2G/320/6L3.0/5R/CB_bgn_1.3C_AL_RU22

Model	RO	Country	Acer Part No	Description
AS5625G-P824G32Mn	EMEA	UK	LX.PV702.024	AS5625G-P824G32Mn W7HP64ATGB1 MC MADISON_PRO1GBCKs_3V3 2*2G/ 320/6L3.0/5R/CB_bgn_1.3C_AL_EN11
AS5625G-P824G32Mn	EMEA	Eastern Europe	LX.PV702.023	AS5625G-P824G32Mn W7HP64ATEU5 MC MADISON_PRO1GBCKs_3V3 2*2G/ 320/6L3.0/5R/CB_bgn_1.3C_AL_RO11
AS5625G-P824G32Mn	EMEA	Eastern Europe	LX.PV702.022	AS5625G-P824G32Mn W7HP64ATEU5 MC MADISON_PRO1GBCKs_3V3 2*2G/ 320/6L3.0/5R/CB_bgn_1.3C_AL_PL71
AS5625G-P824G32Mn	EMEA	Czech	LX.PV702.021	AS5625G-P824G32Mn W7HP64ATCZ2 MC MADISON_PRO1GBCKs_3V3 2*2G/ 320/6L3.0/5R/CB_bgn_1.3C_AL_SK11
AS5625G-P824G32Mn	EMEA	Hungary	LX.PV702.020	AS5625G-P824G32Mn W7HP64ATHU1 MC MADISON_PRO1GBCKs_3V3 2*2G/ 320/6L3.0/5R/CB_bgn_1.3C_AL_HU11
AS5625G-P824G32Mn	EMEA	Israel	LX.PV702.019	AS5625G-P824G32Mn W7HP64ATIL1 MC MADISON_PRO1GBCKs_3V3 2*2G/320/ 6L3.0/5R/CB_bgn_1.3C_AL_HE11
AS5625G-P824G32Mn	EMEA	Baltic	LX.PV702.018	AS5625G-P824G32Mn W7HP64ATBC4 MC MADISON_PRO1GBCKs_3V3 2*2G/ 320/6L3.0/5R/CB_bgn_1.3C_AL_LT11
AS5625G-P824G32Mn	EMEA	Portugal	LX.PV702.017	AS5625G-P824G32Mn W7HP64ATPT1 MC MADISON_PRO1GBCKs_3V3 2*2G/ 320/6L3.0/5R/CB_bgn_1.3C_AL_PT11
AS5625G-P824G32Mn	EMEA	Cyprus	LX.PV702.016	AS5625G-P824G32Mn W7HP64ATCY1 MC MADISON_PRO1GBCKs_3V3 2*2G/ 320/6L3.0/5R/CB_bgn_1.3C_AL_ES61
AS5625G-P824G32Mn	EMEA	Baltic	LX.PV702.015	AS5625G-P824G32Mn W7HP64ATBC3 MC MADISON_PRO1GBCKs_3V3 2*2G/ 320/6L3.0/5R/CB_bgn_1.3C_AL_SV21
AS5625G-P824G32Mn	EMEA	Serbia/ Macedonia	LX.PV702.014	AS5625G-P824G32Mn W7HP64ATCS1 MC MADISON_PRO1GBCKs_3V3 2*2G/ 320/6L3.0/5R/CB_bgn_1.3C_AL_SL11
AS5625G-P824G32Mn	EMEA	Italy	LX.PV702.013	AS5625G-P824G32Mn W7HP64ATIT1 MC MADISON_PRO1GBCKs_3V3 2*2G/320/ 6L3.0/5R/CB_bgn_1.3C_AL_IT11
AS5625G-P824G32Mn	EMEA	Spain	LX.PV702.012	AS5625G-P824G32Mn W7HP64ATES1 MC MADISON_PRO1GBCKs_3V3 2*2G/ 320/6L3.0/5R/CB_bgn_1.3C_AL_ES51
AS5625G-P824G32Mn	EMEA	Denmark	LX.PV702.011	AS5625G-P824G32Mn W7HP64ATDK2 MC MADISON_PRO1GBCKs_3V3 2*2G/ 320/6L3.0/5R/CB_bgn_1.3C_AL_ENS1
AS5625G-P824G32Mn	EMEA	Eastern Europe	LX.PV702.010	AS5625G-P824G32Mn W7HP64ATEU7 MC MADISON_PRO1GBCKs_3V3 2*2G/ 320/6L3.0/5R/CB_bgn_1.3C_AL_ENQ1
AS5625G-P824G32Mn	EMEA	Eastern Europe	LX.PV702.009	AS5625G-P824G32Mn W7HP64ATEU4 MC MADISON_PRO1GBCKs_3V3 2*2G/ 320/6L3.0/5R/CB_bgn_1.3C_AL_SV21
AS5625G-P824G32Mn	EMEA	Greece	LX.PV702.008	AS5625G-P824G32Mn W7HP64ATGR1 MC MADISON_PRO1GBCKs_3V3 2*2G/ 320/6L3.0/5R/CB_bgn_1.3C_AL_EL31

Model	RO	Country	Acer Part No	Description
AS5625G-P824G32Mn	EMEA	Austria	LX.PV702.007	AS5625G-P824G32Mn W7HP64ATAT1 MC MADISON_PRO1GBCKs_3V3 2*2G/320/6L3.0/5R/CB_bgn_1.3C_AL_DE61
AS5625G-P824G32Mn	EMEA	France	LX.PV702.006	AS5625G-P824G32Mn W7HP64ATFR1 MC MADISON_PRO1GBCKs_3V3 2*2G/320/6L3.0/5R/CB_bgn_1.3C_AL_FR21
AS5625G-P824G32Mn	EMEA	Eastern Europe	LX.PV702.005	AS5625G-P824G32Mn W7HP64ATEU7 MC MADISON_PRO1GBCKs_3V3 2*2G/320/6L3.0/5R/CB_bgn_1.3C_AL_SL11
AS5625G-P924G64Mn	CHINA	China	LX.PV702.001	AS5625G-P924G64Mn W7HP64SCATCN1 MC MADISON_PRO1GBCKs_3V3 2*2G/640/BT/6L3.0/5R/CB_bgn_1.3C_AL_SC14
AS5625G-P822G50Mn	TWN	GCTWN	LX.PV702.004	AS5625G-P822G50Mn W7HP64ATTW1 MC MADISON_PRO1GBCKs_3V3 1*2G/500_L/BT/6L3.0/5R/CB_bgn_1.3C_AL_TC11
AS5625G-P922G50Mn	TWN	GCTWN	LX.PV702.003	AS5625G-P922G50Mn W7HP64ATTW1 MC MADISON_PRO1GBCKs_3V3 1*2G/500_L/BT/6L3.0/5R/CB_bgn_1.3C_AL_TC11
AS5625G-P924G50Mi	EMEA	Russia	LX.PV702.002	AS5625G-P924G50Mi W7HP64RUATRU1 MC MADISON_PRO1GBCKs_3V3 2*2G/500_L/BT/6L3.0/5R/CB_bgn_1.3C_AL_RU11
AS5625G-P824G50Mn	EMEA	Germany	LX.PU802.098	AS5625G-P824G50Mn W7HP64ATDE1 MC PARK_XT512Cks_3V3 2*2G/500_L/BT/6L3.0/5R/CB_bgn_1.3C_AL_DE11
AS5625G-P824G50Mn	EMEA	Algeria	LX.PU802.097	AS5625G-P824G50Mn EM W7HP64EMATDZ1 MC PARK_XT512Cks_3V3 2*2G/500_L/6L3.0/5R/CB_bgn_1.3C_AL_ES81
AS5625G-P824G50Mn	EMEA	South Africa	LX.PU802.096	AS5625G-P824G50Mn EM W7HP64EMATZA1 MC PARK_XT512Cks_3V3 2*2G/500_L/6L3.0/5R/CB_bgn_1.3C_AL_ES81
AS5625G-P824G50Mn	EMEA	Middle East	LX.PU802.095	AS5625G-P824G50Mn EM W7HP64EMATME4 MC PARK_XT512Cks_3V3 2*2G/500_L/6L3.0/5R/CB_bgn_1.3C_AL_ES61
AS5625G-P824G50Mn	EMEA	Middle East	LX.PU802.094	AS5625G-P824G50Mn EM W7HP64EMATME2 MC PARK_XT512Cks_3V3 2*2G/500_L/6L3.0/5R/CB_bgn_1.3C_AL_AR11
AS5625G-P824G50Mn	EMEA	Middle East	LX.PU802.093	AS5625G-P824G50Mn EM W7HP64EMATME3 MC PARK_XT512Cks_3V3 2*2G/500_L/6L3.0/5R/CB_bgn_1.3C_AL_ES81
AS5625G-P824G50Mn	EMEA	Middle East	LX.PU802.092	AS5625G-P824G50Mn EM W7HP64EMATME6 MC PARK_XT512Cks_3V3 2*2G/500_L/6L3.0/5R/CB_bgn_1.3C_AL_ES61
AS5625G-P824G50Mn	EMEA	Ukraine	LX.PU802.091	AS5625G-P824G50Mn W7HP64RUATUK1 MC PARK_XT512Cks_3V3 2*2G/500_L/6L3.0/5R/CB_bgn_1.3C_AL_RU61

Model	RO	Country	Acer Part No	Description
AS5625G-P824G50Mi	EMEA	Russia	LX.PU802.090	AS5625G-P824G50Mi W7HP64RUATRU1 MC PARK_XT512Cks_3V3 2*2G/500_L/6L3.0/5R/CB_bgn_1.3C_AL_RU11
AS5625G-P824G50Mn	EMEA	Middle East	LX.PU802.089	AS5625G-P824G50Mn EM W7HP64EMATME4 MC PARK_XT512Cks_3V3 2*2G/500_L/6L3.0/5R/CB_bgn_1.3C_AL_RU61
AS5625G-P824G50Mn	EMEA	Middle East	LX.PU802.088	AS5625G-P824G50Mn EM W7HP64EMATME2 MC PARK_XT512Cks_3V3 2*2G/500_L/6L3.0/5R/CB_bgn_1.3C_AL_ES61
AS5625G-P824G50Mn	EMEA	South Africa	LX.PU802.087	AS5625G-P824G50Mn EM W7HP64EMATZA2 MC PARK_XT512Cks_3V3 2*2G/500_L/6L3.0/5R/CB_bgn_1.3C_AL_ES61
AS5625G-P824G50Mn	EMEA	Turkey	LX.PU802.086	AS5625G-P824G50Mn EM W7HP64EMATTR1 MC PARK_XT512Cks_3V3 2*2G/500_L/6L3.0/5R/CB_bgn_1.3C_AL_TR31
AS5625G-P824G50Mn	EMEA	Middle East	LX.PU802.085	AS5625G-P824G50Mn EM W7HP64EMATMEB MC PARK_XT512Cks_3V3 2*2G/500_L/6L3.0/5R/CB_bgn_1.3C_AL_ARA1
AS5625G-P824G50Mn	EMEA	Middle East	LX.PU802.084	AS5625G-P824G50Mn EM W7HP64EMATME2 MC PARK_XT512Cks_3V3 2*2G/500_L/6L3.0/5R/CB_bgn_1.3C_AL_AR21
AS5625G-P824G50Mn	EMEA	South Africa	LX.PU802.083	AS5625G-P824G50Mn EM W7HP64EMATZA5 MC PARK_XT512Cks_3V3 2*2G/500_L/6L3.0/5R/CB_bgn_1.3C_AL_ES61
AS5625G-P824G50Mn	EMEA	Middle East	LX.PU802.082	AS5625G-P824G50Mn EM W7HP64EMATME9 MC PARK_XT512Cks_3V3 2*2G/500_L/6L3.0/5R/CB_bgn_1.3C_AL_ES81
AS5625G-P824G50Mn	EMEA	South Africa	LX.PU802.081	AS5625G-P824G50Mn EM W7HP64EMATZA4 MC PARK_XT512Cks_3V3 2*2G/500_L/6L3.0/5R/CB_bgn_1.3C_AL_ES61
AS5625G-P824G50Mn	EMEA	Germany	LX.PU802.080	AS5625G-P824G50Mn W7HP64ATDE1 MC PARK_XT512Cks_3V3 2*2G/500_L/6L3.0/5R/CB_bgn_1.3C_AL_DE11
AS5625G-P824G50Mn	EMEA	Poland	LX.PU802.079	AS5625G-P824G50Mn W7HP64ATPL1 MC PARK_XT512Cks_3V3 2*2G/500_L/6L3.0/5R/CB_bgn_1.3C_AL_PL11
AS5625G-P824G50Mn	EMEA	Baltic	LX.PU802.078	AS5625G-P824G50Mn W7HP64ATBC5 MC PARK_XT512Cks_3V3 2*2G/500_L/6L3.0/5R/CB_bgn_1.3C_AL_LT11
AS5625G-P824G50Mn	EMEA	Holland	LX.PU802.077	AS5625G-P824G50Mn W7HP64ATNL1 MC PARK_XT512Cks_3V3 2*2G/500_L/6L3.0/5R/CB_bgn_1.3C_AL_NL11
AS5625G-P824G50Mn	EMEA	Belgium	LX.PU802.076	AS5625G-P824G50Mn W7HP64ATBE1 MC PARK_XT512Cks_3V3 2*2G/500_L/6L3.0/5R/CB_bgn_1.3C_AL_NL11

Model	RO	Country	Acer Part No	Description
AS5625G-P824G50Mn	EMEA	Switzerland	LX.PU802.075	AS5625G-P824G50Mn W7HP64ATCH1 MC PARK_XT512Cks_3V3 2*2G/500_L/6L3.0/5R/CB_bgn_1.3C_AL_IT41
AS5625G-P824G50Mn	EMEA	Luxembourg	LX.PU802.074	AS5625G-P824G50Mn W7HP64ATLU3 MC PARK_XT512Cks_3V3 2*2G/500_L/6L3.0/5R/CB_bgn_1.3C_AL_IT41
AS5625G-P824G50Mn	EMEA	Latvia	LX.PU802.073	AS5625G-P824G50Mn W7HP64ATLV1 MC PARK_XT512Cks_3V3 2*2G/500_L/6L3.0/5R/CB_bgn_1.3C_AL_LT11
AS5625G-P824G50Mn	EMEA	Latvia	LX.PU802.072	AS5625G-P824G50Mn W7HP64ATLV1 MC PARK_XT512Cks_3V3 2*2G/500_L/6L3.0/5R/CB_bgn_1.3C_AL_RU22
AS5625G-P824G50Mn	EMEA	UK	LX.PU802.071	AS5625G-P824G50Mn W7HP64ATGB1 MC PARK_XT512Cks_3V3 2*2G/500_L/6L3.0/5R/CB_bgn_1.3C_AL_EN11
AS5625G-P824G50Mn	EMEA	Eastern Europe	LX.PU802.070	AS5625G-P824G50Mn W7HP64ATEU5 MC PARK_XT512Cks_3V3 2*2G/500_L/6L3.0/5R/CB_bgn_1.3C_AL_RO11
AS5625G-P824G50Mn	EMEA	Eastern Europe	LX.PU802.069	AS5625G-P824G50Mn W7HP64ATEU5 MC PARK_XT512Cks_3V3 2*2G/500_L/6L3.0/5R/CB_bgn_1.3C_AL_PL71
AS5625G-P824G50Mn	EMEA	Czech	LX.PU802.068	AS5625G-P824G50Mn W7HP64ATCZ2 MC PARK_XT512Cks_3V3 2*2G/500_L/6L3.0/5R/CB_bgn_1.3C_AL_SK11
AS5625G-P824G50Mn	EMEA	Hungary	LX.PU802.067	AS5625G-P824G50Mn W7HP64ATHU1 MC PARK_XT512Cks_3V3 2*2G/500_L/6L3.0/5R/CB_bgn_1.3C_AL_HU11
AS5625G-P824G50Mn	EMEA	Israel	LX.PU802.066	AS5625G-P824G50Mn W7HP64ATIL1 MC PARK_XT512Cks_3V3 2*2G/500_L/6L3.0/5R/CB_bgn_1.3C_AL_HE11
AS5625G-P824G50Mn	EMEA	Baltic	LX.PU802.065	AS5625G-P824G50Mn W7HP64ATBC4 MC PARK_XT512Cks_3V3 2*2G/500_L/6L3.0/5R/CB_bgn_1.3C_AL_LT11
AS5625G-P824G50Mn	EMEA	Portugal	LX.PU802.064	AS5625G-P824G50Mn W7HP64ATPT1 MC PARK_XT512Cks_3V3 2*2G/500_L/6L3.0/5R/CB_bgn_1.3C_AL_PT11
AS5625G-P824G50Mn	EMEA	Cyprus	LX.PU802.063	AS5625G-P824G50Mn W7HP64ATCY1 MC PARK_XT512Cks_3V3 2*2G/500_L/6L3.0/5R/CB_bgn_1.3C_AL_ES61
AS5625G-P824G50Mn	EMEA	Baltic	LX.PU802.062	AS5625G-P824G50Mn W7HP64ATBC3 MC PARK_XT512Cks_3V3 2*2G/500_L/6L3.0/5R/CB_bgn_1.3C_AL_SV21
AS5625G-P824G50Mn	EMEA	Serbia/Macedonia	LX.PU802.061	AS5625G-P824G50Mn W7HP64ATCS1 MC PARK_XT512Cks_3V3 2*2G/500_L/6L3.0/5R/CB_bgn_1.3C_AL_SL11
AS5625G-P824G50Mn	EMEA	Italy	LX.PU802.060	AS5625G-P824G50Mn W7HP64ATIT1 MC PARK_XT512Cks_3V3 2*2G/500_L/6L3.0/5R/CB_bgn_1.3C_AL_IT11
AS5625G-P824G50Mn	EMEA	Spain	LX.PU802.059	AS5625G-P824G50Mn W7HP64ATES1 MC PARK_XT512Cks_3V3 2*2G/500_L/6L3.0/5R/CB_bgn_1.3C_AL_ES51

Model	RO	Country	Acer Part No	Description
AS5625G-P824G50Mn	EMEA	Denmark	LX.PU802.058	AS5625G-P824G50Mn W7HP64ATDK2 MC PARK_XT512Cks_3V3 2*2G/500_L/ 6L3.0/5R/CB_bgn_1.3C_AL_ENS1
AS5625G-P824G50Mn	EMEA	Eastern Europe	LX.PU802.057	AS5625G-P824G50Mn W7HP64ATEU7 MC PARK_XT512Cks_3V3 2*2G/500_L/ 6L3.0/5R/CB_bgn_1.3C_AL_ENQ1
AS5625G-P824G50Mn	EMEA	Eastern Europe	LX.PU802.056	AS5625G-P824G50Mn W7HP64ATEU4 MC PARK_XT512Cks_3V3 2*2G/500_L/ 6L3.0/5R/CB_bgn_1.3C_AL_SV21
AS5625G-P824G50Mn	EMEA	Greece	LX.PU802.055	AS5625G-P824G50Mn W7HP64ATGR1 MC PARK_XT512Cks_3V3 2*2G/500_L/ 6L3.0/5R/CB_bgn_1.3C_AL_EL31
AS5625G-P824G50Mn	EMEA	Austria	LX.PU802.054	AS5625G-P824G50Mn W7HP64ATAT1 MC PARK_XT512Cks_3V3 2*2G/500_L/6L3.0/ 5R/CB_bgn_1.3C_AL_DE61
AS5625G-P824G50Mn	EMEA	France	LX.PU802.053	AS5625G-P824G50Mn W7HP64ATFR1 MC PARK_XT512Cks_3V3 2*2G/500_L/ 6L3.0/5R/CB_bgn_1.3C_AL_FR21
AS5625G-P824G50Mn	EMEA	Eastern Europe	LX.PU802.052	AS5625G-P824G50Mn W7HP64ATEU7 MC PARK_XT512Cks_3V3 2*2G/500_L/ 6L3.0/5R/CB_bgn_1.3C_AL_SL11
AS5625G-P822G50Mn	TWN	GCTWN	LX.PU802.051	AS5625G-P822G50Mn W7HP64ATTW1 MC PARK_XT512Cks_3V3 1*2G/500_L/ BT/6L3.0/5R/CB_bgn_1.3C_AL_TC11
AS5625G-P322G50Mn	TWN	GCTWN	LX.PU802.050	AS5625G-P322G50Mn W7HP64ATTW1 MC PARK_XT512Cks_3V3 1*2G/500_L/ BT/6L3.0/5R/CB_bgn_1.3C_AL_TC11
AS5625G-P522G50Mn	TWN	GCTWN	LX.PU802.049	AS5625G-P522G50Mn W7HP64ATTW1 MC PARK_XT512Cks_3V3 1*2G/500_L/ BT/6L3.0/5R/CB_bgn_1.3C_AL_TC11
AS5625G-P324G32Mn	EMEA	Ukraine	LX.PU802.048	AS5625G-P324G32Mn W7HP64RUATUK1 MC PARK_XT512Cks_3V3 2*2G/320/ 6L3.0/5R/CB_bgn_1.3C_AL_RU61
AS5625G-P324G32Mi	EMEA	Russia	LX.PU802.047	AS5625G-P324G32Mi W7HP64RUATRU1 MC PARK_XT512Cks_3V3 2*2G/320/ 6L3.0/5R/CB_bg_1.3C_AL_RU11
AS5625G-P324G32Mn	EMEA	Middle East	LX.PU802.046	AS5625G-P324G32Mn EM W7HP64EMATME4 MC PARK_XT512Cks_3V3 2*2G/320/6L3.0/5R/ CB_bgn_1.3C_AL_RU61
AS5625G-P324G32Mn	EMEA	Middle East	LX.PU802.045	AS5625G-P324G32Mn EM W7HP64EMATME2 MC PARK_XT512Cks_3V3 2*2G/320/6L3.0/5R/ CB_bgn_1.3C_AL_ES61
AS5625G-P324G32Mn	EMEA	South Africa	LX.PU802.044	AS5625G-P324G32Mn EM W7HP64EMATZA2 MC PARK_XT512Cks_3V3 2*2G/320/6L3.0/5R/ CB_bgn_1.3C_AL_ES61
AS5625G-P324G32Mn	EMEA	Turkey	LX.PU802.043	AS5625G-P324G32Mn EM W7HP64EMATTR1 MC PARK_XT512Cks_3V3 2*2G/320/6L3.0/5R/ CB_bgn_1.3C_AL_TR31

Model	RO	Country	Acer Part No	Description
AS5625G-P324G32Mn	EMEA	Middle East	LX.PU802.042	AS5625G-P324G32Mn EM W7HP64EMATMEB MC PARK_XT512Cks_3V3 2*2G/320/6L3.0/5R/CB_bgn_1.3C_AL_ARA1
AS5625G-P324G32Mn	EMEA	Middle East	LX.PU802.041	AS5625G-P324G32Mn EM W7HP64EMATME2 MC PARK_XT512Cks_3V3 2*2G/320/6L3.0/5R/CB_bgn_1.3C_AL_AR21
AS5625G-P324G32Mn	EMEA	South Africa	LX.PU802.040	AS5625G-P324G32Mn EM W7HP64EMATZA5 MC PARK_XT512Cks_3V3 2*2G/320/6L3.0/5R/CB_bgn_1.3C_AL_ES61
AS5625G-P324G32Mn	EMEA	Middle East	LX.PU802.039	AS5625G-P324G32Mn EM W7HP64EMATME9 MC PARK_XT512Cks_3V3 2*2G/320/6L3.0/5R/CB_bgn_1.3C_AL_ES81
AS5625G-P324G32Mn	EMEA	Algeria	LX.PU802.038	AS5625G-P324G32Mn EM W7HP64EMATDZ1 MC PARK_XT512Cks_3V3 2*2G/320/6L3.0/5R/CB_bgn_1.3C_AL_ES81
AS5625G-P324G32Mn	EMEA	South Africa	LX.PU802.037	AS5625G-P324G32Mn EM W7HP64EMATZA1 MC PARK_XT512Cks_3V3 2*2G/320/6L3.0/5R/CB_bgn_1.3C_AL_ES81
AS5625G-P324G32Mn	EMEA	Middle East	LX.PU802.036	AS5625G-P324G32Mn EM W7HP64EMATME4 MC PARK_XT512Cks_3V3 2*2G/320/6L3.0/5R/CB_bgn_1.3C_AL_ES61
AS5625G-P324G32Mn	EMEA	Middle East	LX.PU802.035	AS5625G-P324G32Mn EM W7HP64EMATME2 MC PARK_XT512Cks_3V3 2*2G/320/6L3.0/5R/CB_bgn_1.3C_AL_AR11
AS5625G-P324G32Mn	EMEA	Middle East	LX.PU802.034	AS5625G-P324G32Mn EM W7HP64EMATME3 MC PARK_XT512Cks_3V3 2*2G/320/6L3.0/5R/CB_bgn_1.3C_AL_ES81
AS5625G-P324G32Mn	EMEA	Middle East	LX.PU802.033	AS5625G-P324G32Mn EM W7HP64EMATME6 MC PARK_XT512Cks_3V3 2*2G/320/6L3.0/5R/CB_bgn_1.3C_AL_ES61
AS5625G-P324G32Mn	EMEA	South Africa	LX.PU802.032	AS5625G-P324G32Mn EM W7HP64EMATZA4 MC PARK_XT512Cks_3V3 2*2G/320/6L3.0/5R/CB_bgn_1.3C_AL_ES61
AS5625G-P324G32Mn	EMEA	Switzerland	LX.PU802.031	AS5625G-P324G32Mn W7HP64ATCH1 MC PARK_XT512Cks_3V3 2*2G/320/6L3.0/5R/CB_bgn_1.3C_AL_IT41
AS5625G-P324G32Mn	EMEA	Germany	LX.PU802.030	AS5625G-P324G32Mn W7HP64ATDE1 MC PARK_XT512Cks_3V3 2*2G/320/6L3.0/5R/CB_bgn_1.3C_AL_DE11
AS5625G-P324G32Mn	EMEA	Poland	LX.PU802.029	AS5625G-P324G32Mn W7HP64ATPL1 MC PARK_XT512Cks_3V3 2*2G/320/6L3.0/5R/CB_bgn_1.3C_AL_PL11

Model	RO	Country	Acer Part No	Description
AS5625G-P324G32Mn	EMEA	Baltic	LX.PU802.028	AS5625G-P324G32Mn W7HP64ATBC5 MC PARK_XT512Cks_3V3 2*2G/320/ 6L3.0/5R/CB_bgn_1.3C_AL_LT11
AS5625G-P324G32Mn	EMEA	Holland	LX.PU802.027	AS5625G-P324G32Mn W7HP64ATNL1 MC PARK_XT512Cks_3V3 2*2G/320/ 6L3.0/5R/CB_bgn_1.3C_AL_NL11
AS5625G-P324G32Mn	EMEA	Belgium	LX.PU802.026	AS5625G-P324G32Mn W7HP64ATBE1 MC PARK_XT512Cks_3V3 2*2G/320/ 6L3.0/5R/CB_bgn_1.3C_AL_NL11
AS5625G-P324G32Mn	EMEA	Luxembo urg	LX.PU802.025	AS5625G-P324G32Mn W7HP64ATLU3 MC PARK_XT512Cks_3V3 2*2G/320/ 6L3.0/5R/CB_bgn_1.3C_AL_IT41
AS5625G-P324G32Mn	EMEA	Latvia	LX.PU802.024	AS5625G-P324G32Mn W7HP64ATLV1 MC PARK_XT512Cks_3V3 2*2G/320/6L3.0/5R/ CB_bgn_1.3C_AL_LT11
AS5625G-P324G32Mn	EMEA	Latvia	LX.PU802.023	AS5625G-P324G32Mn W7HP64ATLV1 MC PARK_XT512Cks_3V3 2*2G/320/6L3.0/5R/ CB_bgn_1.3C_AL_RU22
AS5625G-P324G32Mn	EMEA	UK	LX.PU802.022	AS5625G-P324G32Mn W7HP64ATGB1 MC PARK_XT512Cks_3V3 2*2G/320/ 6L3.0/5R/CB_bgn_1.3C_AL_EN11
AS5625G-P324G32Mn	EMEA	Eastern Europe	LX.PU802.021	AS5625G-P324G32Mn W7HP64ATEU5 MC PARK_XT512Cks_3V3 2*2G/320/ 6L3.0/5R/CB_bgn_1.3C_AL_RO11
AS5625G-P324G32Mn	EMEA	Eastern Europe	LX.PU802.020	AS5625G-P324G32Mn W7HP64ATEU5 MC PARK_XT512Cks_3V3 2*2G/320/ 6L3.0/5R/CB_bgn_1.3C_AL_PL71
AS5625G-P324G32Mn	EMEA	Czech	LX.PU802.019	AS5625G-P324G32Mn W7HP64ATCZ2 MC PARK_XT512Cks_3V3 2*2G/320/ 6L3.0/5R/CB_bgn_1.3C_AL_SK11
AS5625G-P324G32Mn	EMEA	Hungary	LX.PU802.018	AS5625G-P324G32Mn W7HP64ATHU1 MC PARK_XT512Cks_3V3 2*2G/320/ 6L3.0/5R/CB_bgn_1.3C_AL_HU11
AS5625G-P324G32Mn	EMEA	Israel	LX.PU802.017	AS5625G-P324G32Mn W7HP64ATIL1 MC PARK_XT512Cks_3V3 2*2G/320/6L3.0/5R/ CB_bgn_1.3C_AL_HE11
AS5625G-P324G32Mn	EMEA	Baltic	LX.PU802.016	AS5625G-P324G32Mn W7HP64ATBC4 MC PARK_XT512Cks_3V3 2*2G/320/ 6L3.0/5R/CB_bgn_1.3C_AL_LT11
AS5625G-P324G32Mn	EMEA	Portugal	LX.PU802.015	AS5625G-P324G32Mn W7HP64ATPT1 MC PARK_XT512Cks_3V3 2*2G/320/ 6L3.0/5R/CB_bgn_1.3C_AL_PT11
AS5625G-P324G32Mn	EMEA	Cyprus	LX.PU802.014	AS5625G-P324G32Mn W7HP64ATCY1 MC PARK_XT512Cks_3V3 2*2G/320/ 6L3.0/5R/CB_bgn_1.3C_AL_ES61
AS5625G-P324G32Mn	EMEA	Baltic	LX.PU802.013	AS5625G-P324G32Mn W7HP64ATBC3 MC PARK_XT512Cks_3V3 2*2G/320/ 6L3.0/5R/CB_bgn_1.3C_AL_SV21
AS5625G-P324G32Mn	EMEA	Serbia/ Macedon ia	LX.PU802.012	AS5625G-P324G32Mn W7HP64ATCS1 MC PARK_XT512Cks_3V3 2*2G/320/ 6L3.0/5R/CB_bgn_1.3C_AL_SL11

Model	RO	Country	Acer Part No	Description
AS5625G-P324G32Mn	EMEA	Italy	LX.PU802.011	AS5625G-P324G32Mn W7HP64ATIT1 MC PARK_XT512Cks_3V3 2*2G/320/6L3.0/5R/CB_bgn_1.3C_AL_IT11
AS5625G-P324G32Mn	EMEA	Spain	LX.PU802.010	AS5625G-P324G32Mn W7HP64ATES1 MC PARK_XT512Cks_3V3 2*2G/320/6L3.0/5R/CB_bgn_1.3C_AL_ES51
AS5625G-P324G32Mn	EMEA	Denmark	LX.PU802.009	AS5625G-P324G32Mn W7HP64ATDK2 MC PARK_XT512Cks_3V3 2*2G/320/6L3.0/5R/CB_bgn_1.3C_AL_ENS1
AS5625G-P324G32Mn	EMEA	Eastern Europe	LX.PU802.008	AS5625G-P324G32Mn W7HP64ATEU7 MC PARK_XT512Cks_3V3 2*2G/320/6L3.0/5R/CB_bgn_1.3C_AL_ENQ1
AS5625G-P324G32Mn	EMEA	Eastern Europe	LX.PU802.007	AS5625G-P324G32Mn W7HP64ATEU4 MC PARK_XT512Cks_3V3 2*2G/320/6L3.0/5R/CB_bgn_1.3C_AL_SV21
AS5625G-P324G32Mn	EMEA	Greece	LX.PU802.006	AS5625G-P324G32Mn W7HP64ATGR1 MC PARK_XT512Cks_3V3 2*2G/320/6L3.0/5R/CB_bgn_1.3C_AL_EL31
AS5625G-P324G32Mn	EMEA	Austria	LX.PU802.005	AS5625G-P324G32Mn W7HP64ATAT1 MC PARK_XT512Cks_3V3 2*2G/320/6L3.0/5R/CB_bgn_1.3C_AL_DE61
AS5625G-P324G32Mn	EMEA	France	LX.PU802.004	AS5625G-P324G32Mn W7HP64ATFR1 MC PARK_XT512Cks_3V3 2*2G/320/6L3.0/5R/CB_bgn_1.3C_AL_FR21
AS5625G-P324G32Mn	EMEA	Eastern Europe	LX.PU802.003	AS5625G-P324G32Mn W7HP64ATEU7 MC PARK_XT512Cks_3V3 2*2G/320/6L3.0/5R/CB_bgn_1.3C_AL_SL11
AS5625G-P824G64Mn	EMEA	Spain	LX.PU802.001	AS5625G-P824G64Mn W7HP64ATES1 MC PARK_XT512Cks_3V3 2*2G/640/BT/6L3.0/5R/CB_bgn_1.3C_AL_ES51
AS5625G-P824G50Mn	EMEA	Spain	LX.PU802.002	AS5625G-P824G50Mn W7HP64ATES1 MC PARK_XT512Cks_3V3 2*2G/500_L/BT/6L3.0/5R/CB_bgn_1.3C_AL_ES51
AS5625G-N533G32Mn	WW	WW	S2.PU802.002	AS5625G-N533G32Mn W7HP64AWW1 MC PARK_XT512Cks_3V3 2G+1G/320/BT/6L3.0/5R/CB_bgn_1.3C_AL_ES62
AS5625G-N334G32Mn	WW	WW	S2.PU802.001	AS5625G-N334G32Mn W7HP64AWW1 MC PARK_XT512Cks_3V3 2*2G/320/BT/6L3.0/5R/CB_bgn_1.3C_AL_ES62
AS5625-P324G32Mn	EMEA	Germany	LX.PV602.002	AS5625-P324G32Mn W7HP64ATDE1 MC UMACKs_3 2*2G/320/6L3.0/5R/CB_bgn_1.3C_AL_DE11
AS5625-P323G32Mn	EMEA	UK	LX.PV602.001	AS5625-P323G32Mn W7HP64ATGB1 MC UMACKs_3 2G+1G/320/6L3.0/5R/CB_bgn_1.3C_AL_EN11
AS5625-P522G25Mn	WW	WW	S2.PV602.003	AS5625-P522G25Mn W7HP64AWW1 MC UMACKs_3 2*1G/250/BT/6L3.0/5R/CB_bgn_1.3C_AL_ES62
AS5625-N332G25Mn	WW	WW	S2.PV602.002	AS5625-N332G25Mn W7HP64AWW1 MC UMACKs_3 2*1G/250/BT/6L3.0/5R/CB_bgn_1.3C_AL_ES62

Model	CPU	LCD	VGA Chip	VRAM 1	Memory 1	Memory 2
AS5625G-P924G64Mn	APP920	NLED15.6W XGAGS	MADISO N_PRO	1G-DDR3 (64*16*8)	SO2GBIII10	SO2GBIII10
AS5625G-P822G50Mn	APP820	NLED15.6W XGAGS	MADISO N_PRO	1G-DDR3 (64*16*8)	SO2GBIII10	N
AS5625G-P922G50Mn	APP920	NLED15.6W XGAGS	MADISO N_PRO	1G-DDR3 (64*16*8)	SO2GBIII10	N
AS5625G-P924G50Mi	APP920	NLED15.6W XGAGS	MADISO N_PRO	1G-DDR3 (64*16*8)	SO2GBIII10	SO2GBIII10
AS5625G-P824G50Mn	APP820	NLED15.6W XGAGS	PARK_X T	512M-DDR3 (64*16*4)	SO2GBIII10	SO2GBIII10
AS5625G-P824G50Mn	APP820	NLED15.6W XGAGS	PARK_X T	512M-DDR3 (64*16*4)	SO2GBIII10	SO2GBIII10
AS5625G-P824G50Mn	APP820	NLED15.6W XGAGS	PARK_X T	512M-DDR3 (64*16*4)	SO2GBIII10	SO2GBIII10
AS5625G-P824G50Mn	APP820	NLED15.6W XGAGS	PARK_X T	512M-DDR3 (64*16*4)	SO2GBIII10	SO2GBIII10
AS5625G-P824G50Mn	APP820	NLED15.6W XGAGS	PARK_X T	512M-DDR3 (64*16*4)	SO2GBIII10	SO2GBIII10
AS5625G-P824G50Mn	APP820	NLED15.6W XGAGS	PARK_X T	512M-DDR3 (64*16*4)	SO2GBIII10	SO2GBIII10
AS5625G-P824G50Mn	APP820	NLED15.6W XGAGS	PARK_X T	512M-DDR3 (64*16*4)	SO2GBIII10	SO2GBIII10
AS5625G-P824G50Mi	APP820	NLED15.6W XGAGS	PARK_X T	512M-DDR3 (64*16*4)	SO2GBIII10	SO2GBIII10
AS5625G-P824G50Mn	APP820	NLED15.6W XGAGS	PARK_X T	512M-DDR3 (64*16*4)	SO2GBIII10	SO2GBIII10
AS5625G-P824G50Mn	APP820	NLED15.6W XGAGS	PARK_X T	512M-DDR3 (64*16*4)	SO2GBIII10	SO2GBIII10
AS5625G-P824G50Mn	APP820	NLED15.6W XGAGS	PARK_X T	512M-DDR3 (64*16*4)	SO2GBIII10	SO2GBIII10
AS5625G-P824G50Mn	APP820	NLED15.6W XGAGS	PARK_X T	512M-DDR3 (64*16*4)	SO2GBIII10	SO2GBIII10
AS5625G-P824G50Mn	APP820	NLED15.6W XGAGS	PARK_X T	512M-DDR3 (64*16*4)	SO2GBIII10	SO2GBIII10
AS5625G-P824G50Mn	APP820	NLED15.6W XGAGS	PARK_X T	512M-DDR3 (64*16*4)	SO2GBIII10	SO2GBIII10
AS5625G-P824G50Mn	APP820	NLED15.6W XGAGS	PARK_X T	512M-DDR3 (64*16*4)	SO2GBIII10	SO2GBIII10

Model	CPU	LCD	VGA Chip	VRAM 1	Memory 1	Memory 2
AS5625G-P824G50Mn	APP820	NLED15.6W XGAGS	PARK_X T	512M- DDR3 (64*16*4)	SO2GBIII10	SO2GBIII10
AS5625G-P824G50Mn	APP820	NLED15.6W XGAGS	PARK_X T	512M- DDR3 (64*16*4)	SO2GBIII10	SO2GBIII10
AS5625G-P824G50Mn	APP820	NLED15.6W XGAGS	PARK_X T	512M- DDR3 (64*16*4)	SO2GBIII10	SO2GBIII10
AS5625G-P824G50Mn	APP820	NLED15.6W XGAGS	PARK_X T	512M- DDR3 (64*16*4)	SO2GBIII10	SO2GBIII10
AS5625G-P824G50Mn	APP820	NLED15.6W XGAGS	PARK_X T	512M- DDR3 (64*16*4)	SO2GBIII10	SO2GBIII10
AS5625G-P824G50Mn	APP820	NLED15.6W XGAGS	PARK_X T	512M- DDR3 (64*16*4)	SO2GBIII10	SO2GBIII10
AS5625G-P824G50Mn	APP820	NLED15.6W XGAGS	PARK_X T	512M- DDR3 (64*16*4)	SO2GBIII10	SO2GBIII10
AS5625G-P824G50Mn	APP820	NLED15.6W XGAGS	PARK_X T	512M- DDR3 (64*16*4)	SO2GBIII10	SO2GBIII10
AS5625G-P824G50Mn	APP820	NLED15.6W XGAGS	PARK_X T	512M- DDR3 (64*16*4)	SO2GBIII10	SO2GBIII10
AS5625G-P824G50Mn	APP820	NLED15.6W XGAGS	PARK_X T	512M- DDR3 (64*16*4)	SO2GBIII10	SO2GBIII10
AS5625G-P824G50Mn	APP820	NLED15.6W XGAGS	PARK_X T	512M- DDR3 (64*16*4)	SO2GBIII10	SO2GBIII10
AS5625G-P824G50Mn	APP820	NLED15.6W XGAGS	PARK_X T	512M- DDR3 (64*16*4)	SO2GBIII10	SO2GBIII10
AS5625G-P824G50Mn	APP820	NLED15.6W XGAGS	PARK_X T	512M- DDR3 (64*16*4)	SO2GBIII10	SO2GBIII10
AS5625G-P824G50Mn	APP820	NLED15.6W XGAGS	PARK_X T	512M- DDR3 (64*16*4)	SO2GBIII10	SO2GBIII10
AS5625G-P824G50Mn	APP820	NLED15.6W XGAGS	PARK_X T	512M- DDR3 (64*16*4)	SO2GBIII10	SO2GBIII10
AS5625G-P824G50Mn	APP820	NLED15.6W XGAGS	PARK_X T	512M- DDR3 (64*16*4)	SO2GBIII10	SO2GBIII10
AS5625G-P824G50Mn	APP820	NLED15.6W XGAGS	PARK_X T	512M- DDR3 (64*16*4)	SO2GBIII10	SO2GBIII10
AS5625G-P822G50Mn	APP820	NLED15.6W XGAGS	PARK_X T	512M- DDR3 (64*16*4)	SO2GBIII10	N

Model	CPU	LCD	VGA Chip	VRAM 1	Memory 1	Memory 2
AS5625G-P322G50Mn	AAP320	NLED15.6W XGAGS	PARK_X T	512M- DDR3 (64*16*4)	SO2GBIII10	N
AS5625G-P522G50Mn	ATP520	NLED15.6W XGAGS	PARK_X T	512M- DDR3 (64*16*4)	SO2GBIII10	N
AS5625G-P324G32Mn	AAP320	NLED15.6W XGAGS	PARK_X T	512M- DDR3 (64*16*4)	SO2GBIII10	SO2GBIII10
AS5625G-P324G32Mi	AAP320	NLED15.6W XGAGS	PARK_X T	512M- DDR3 (64*16*4)	SO2GBIII10	SO2GBIII10
AS5625G-P324G32Mn	AAP320	NLED15.6W XGAGS	PARK_X T	512M- DDR3 (64*16*4)	SO2GBIII10	SO2GBIII10
AS5625G-P324G32Mn	AAP320	NLED15.6W XGAGS	PARK_X T	512M- DDR3 (64*16*4)	SO2GBIII10	SO2GBIII10
AS5625G-P324G32Mn	AAP320	NLED15.6W XGAGS	PARK_X T	512M- DDR3 (64*16*4)	SO2GBIII10	SO2GBIII10
AS5625G-P324G32Mn	AAP320	NLED15.6W XGAGS	PARK_X T	512M- DDR3 (64*16*4)	SO2GBIII10	SO2GBIII10
AS5625G-P324G32Mn	AAP320	NLED15.6W XGAGS	PARK_X T	512M- DDR3 (64*16*4)	SO2GBIII10	SO2GBIII10
AS5625G-P324G32Mn	AAP320	NLED15.6W XGAGS	PARK_X T	512M- DDR3 (64*16*4)	SO2GBIII10	SO2GBIII10
AS5625G-P324G32Mn	AAP320	NLED15.6W XGAGS	PARK_X T	512M- DDR3 (64*16*4)	SO2GBIII10	SO2GBIII10
AS5625G-P324G32Mn	AAP320	NLED15.6W XGAGS	PARK_X T	512M- DDR3 (64*16*4)	SO2GBIII10	SO2GBIII10
AS5625G-P324G32Mn	AAP320	NLED15.6W XGAGS	PARK_X T	512M- DDR3 (64*16*4)	SO2GBIII10	SO2GBIII10
AS5625G-P324G32Mn	AAP320	NLED15.6W XGAGS	PARK_X T	512M- DDR3 (64*16*4)	SO2GBIII10	SO2GBIII10
AS5625G-P324G32Mn	AAP320	NLED15.6W XGAGS	PARK_X T	512M- DDR3 (64*16*4)	SO2GBIII10	SO2GBIII10
AS5625G-P324G32Mn	AAP320	NLED15.6W XGAGS	PARK_X T	512M- DDR3 (64*16*4)	SO2GBIII10	SO2GBIII10
AS5625G-P324G32Mn	AAP320	NLED15.6W XGAGS	PARK_X T	512M- DDR3 (64*16*4)	SO2GBIII10	SO2GBIII10
AS5625G-P324G32Mn	AAP320	NLED15.6W XGAGS	PARK_X T	512M- DDR3 (64*16*4)	SO2GBIII10	SO2GBIII10

Model	CPU	LCD	VGA Chip	VRAM 1	Memory 1	Memory 2
AS5625G-P324G32Mn	AAP320	NLED15.6W XGAGS	PARK_X T	512M- DDR3 (64*16*4)	SO2GBIII10	SO2GBIII10
AS5625G-P324G32Mn	AAP320	NLED15.6W XGAGS	PARK_X T	512M- DDR3 (64*16*4)	SO2GBIII10	SO2GBIII10
AS5625G-P324G32Mn	AAP320	NLED15.6W XGAGS	PARK_X T	512M- DDR3 (64*16*4)	SO2GBIII10	SO2GBIII10
AS5625G-P324G32Mn	AAP320	NLED15.6W XGAGS	PARK_X T	512M- DDR3 (64*16*4)	SO2GBIII10	SO2GBIII10
AS5625G-P324G32Mn	AAP320	NLED15.6W XGAGS	PARK_X T	512M- DDR3 (64*16*4)	SO2GBIII10	SO2GBIII10
AS5625G-P324G32Mn	AAP320	NLED15.6W XGAGS	PARK_X T	512M- DDR3 (64*16*4)	SO2GBIII10	SO2GBIII10
AS5625G-P324G32Mn	AAP320	NLED15.6W XGAGS	PARK_X T	512M- DDR3 (64*16*4)	SO2GBIII10	SO2GBIII10
AS5625G-P324G32Mn	AAP320	NLED15.6W XGAGS	PARK_X T	512M- DDR3 (64*16*4)	SO2GBIII10	SO2GBIII10
AS5625G-P324G32Mn	AAP320	NLED15.6W XGAGS	PARK_X T	512M- DDR3 (64*16*4)	SO2GBIII10	SO2GBIII10
AS5625G-P324G32Mn	AAP320	NLED15.6W XGAGS	PARK_X T	512M- DDR3 (64*16*4)	SO2GBIII10	SO2GBIII10
AS5625G-P324G32Mn	AAP320	NLED15.6W XGAGS	PARK_X T	512M- DDR3 (64*16*4)	SO2GBIII10	SO2GBIII10
AS5625G-P324G32Mn	AAP320	NLED15.6W XGAGS	PARK_X T	512M- DDR3 (64*16*4)	SO2GBIII10	SO2GBIII10
AS5625G-P324G32Mn	AAP320	NLED15.6W XGAGS	PARK_X T	512M- DDR3 (64*16*4)	SO2GBIII10	SO2GBIII10
AS5625G-P324G32Mn	AAP320	NLED15.6W XGAGS	PARK_X T	512M- DDR3 (64*16*4)	SO2GBIII10	SO2GBIII10
AS5625G-P324G32Mn	AAP320	NLED15.6W XGAGS	PARK_X T	512M- DDR3 (64*16*4)	SO2GBIII10	SO2GBIII10
AS5625G-P324G32Mn	AAP320	NLED15.6W XGAGS	PARK_X T	512M- DDR3 (64*16*4)	SO2GBIII10	SO2GBIII10
AS5625G-P324G32Mn	AAP320	NLED15.6W XGAGS	PARK_X T	512M- DDR3 (64*16*4)	SO2GBIII10	SO2GBIII10

Model	CPU	LCD	VGA Chip	VRAM 1	Memory 1	Memory 2
AS5625G-P324G32Mn	AAP320	NLED15.6W XGAGS	PARK_X T	512M- DDR3 (64*16*4)	SO2GBIII10	SO2GBIII10
AS5625G-P324G32Mn	AAP320	NLED15.6W XGAGS	PARK_X T	512M- DDR3 (64*16*4)	SO2GBIII10	SO2GBIII10
AS5625G-P324G32Mn	AAP320	NLED15.6W XGAGS	PARK_X T	512M- DDR3 (64*16*4)	SO2GBIII10	SO2GBIII10
AS5625G-P324G32Mn	AAP320	NLED15.6W XGAGS	PARK_X T	512M- DDR3 (64*16*4)	SO2GBIII10	SO2GBIII10
AS5625G-P324G32Mn	AAP320	NLED15.6W XGAGS	PARK_X T	512M- DDR3 (64*16*4)	SO2GBIII10	SO2GBIII10
AS5625G-P324G32Mn	AAP320	NLED15.6W XGAGS	PARK_X T	512M- DDR3 (64*16*4)	SO2GBIII10	SO2GBIII10
AS5625G-P324G32Mn	AAP320	NLED15.6W XGAGS	PARK_X T	512M- DDR3 (64*16*4)	SO2GBIII10	SO2GBIII10
AS5625G-P324G32Mn	AAP320	NLED15.6W XGAGS	PARK_X T	512M- DDR3 (64*16*4)	SO2GBIII10	SO2GBIII10
AS5625G-P324G32Mn	AAP320	NLED15.6W XGAGS	PARK_X T	512M- DDR3 (64*16*4)	SO2GBIII10	SO2GBIII10
AS5625G-P324G32Mn	AAP320	NLED15.6W XGAGS	PARK_X T	512M- DDR3 (64*16*4)	SO2GBIII10	SO2GBIII10
AS5625G-P324G32Mn	AAP320	NLED15.6W XGAGS	PARK_X T	512M- DDR3 (64*16*4)	SO2GBIII10	SO2GBIII10
AS5625G-P324G32Mn	AAP320	NLED15.6W XGAGS	PARK_X T	512M- DDR3 (64*16*4)	SO2GBIII10	SO2GBIII10
AS5625G-P324G32Mn	AAP320	NLED15.6W XGAGS	PARK_X T	512M- DDR3 (64*16*4)	SO2GBIII10	SO2GBIII10
AS5625G-P824G64Mn	APP820	NLED15.6W XGAGS	PARK_X T	512M- DDR3 (64*16*4)	SO2GBIII10	SO2GBIII10
AS5625G-P824G50Mn	APP820	NLED15.6W XGAGS	PARK_X T	512M- DDR3 (64*16*4)	SO2GBIII10	SO2GBIII10
AS5625G-N533G32Mn	ATN530	NLED15.6W XGAGS	PARK_X T	512M- DDR3 (64*16*4)	SO2GBIII10	SO1GBIII10

Model	CPU	LCD	VGA Chip	VRAM 1	Memory 1	Memory 2
AS5625G-N334G32Mn	AAN330	NLED15.6W XGAGS	PARK_X T	512M- DDR3 (64*16*4)	SO2GBIII10	SO2GBIII10
AS5625-P324G32Mn	AAP320	NLED15.6W XGAGS	UMA	N	SO2GBIII10	SO2GBIII10
AS5625-P323G32Mn	AAP320	NLED15.6W XGAGS	UMA	N	SO2GBIII10	SO1GBIII10
AS5625-P522G25Mn	ATP520	NLED15.6W XGAGS	UMA	N	SO1GBIII10	SO1GBIII10
AS5625-N332G25Mn	AAN330	NLED15.6W XGAGS	UMA	N	SO1GBIII10	SO1GBIII10
AS5625-N332G50Mn	AAN330	NLED15.6W XGAGS	UMA	N	SO2GBIII10	N

Model	HDD 1(GB)	ODD	Wireless LAN1	Bluetooth
AS5625G-P924G50Mn	N500GB5.4KS	NSM8XS9.5	3rd WiFi 2x2 BGN	BT 2.1
AS5625G-P824G50Mn	N500GB5.4KS	NSM8XS9.5	3rd WiFi 2x2 BGN	BT 2.1
AS5625G-P924G50Mn	N500GB5.4KS	NSM8XS9.5	3rd WiFi 2x2 BGN	N
AS5625G-P924G50Mn	N500GB5.4KS	NSM8XS9.5	3rd WiFi 2x2 BGN	N
AS5625G-P924G50Mn	N500GB5.4KS	NSM8XS9.5	3rd WiFi 2x2 BGN	N
AS5625G-P924G50Mn	N500GB5.4KS	NSM8XS9.5	3rd WiFi 2x2 BGN	N
AS5625G-P924G50Mi	N500GB5.4KS	NSM8XS9.5	3rd WiFi BG	N
AS5625G-P924G50Mn	N500GB5.4KS	NSM8XS9.5	3rd WiFi 2x2 BGN	N
AS5625G-P924G50Mn	N500GB5.4KS	NSM8XS9.5	3rd WiFi 2x2 BGN	N
AS5625G-P924G50Mn	N500GB5.4KS	NSM8XS9.5	3rd WiFi 2x2 BGN	N
AS5625G-P924G50Mn	N500GB5.4KS	NSM8XS9.5	3rd WiFi 2x2 BGN	N
AS5625G-P924G50Mn	N500GB5.4KS	NSM8XS9.5	3rd WiFi 2x2 BGN	N
AS5625G-P924G50Mn	N500GB5.4KS	NSM8XS9.5	3rd WiFi 2x2 BGN	N
AS5625G-P924G50Mn	N500GB5.4KS	NSM8XS9.5	3rd WiFi 2x2 BGN	N
AS5625G-P924G50Mn	N500GB5.4KS	NSM8XS9.5	3rd WiFi 2x2 BGN	N
AS5625G-P924G50Mn	N500GB5.4KS	NSM8XS9.5	3rd WiFi 2x2 BGN	N
AS5625G-P924G50Mn	N500GB5.4KS	NSM8XS9.5	3rd WiFi 2x2 BGN	N
AS5625G-P924G50Mn	N500GB5.4KS	NSM8XS9.5	3rd WiFi 2x2 BGN	N
AS5625G-P924G50Mn	N500GB5.4KS	NSM8XS9.5	3rd WiFi 2x2 BGN	N

Model	HDD 1(GB)	ODD	Wireless LAN1	Bluetooth
AS5625G-P324G32Mn	N320GB5.4KS	NSM8XS9.5	3rd WiFi 2x2 BGN	N
AS5625G-P324G32Mn	N320GB5.4KS	NSM8XS9.5	3rd WiFi 2x2 BGN	N
AS5625G-P824G64Mn	N640GB5.4KS	NSM8XS9.5	3rd WiFi 2x2 BGN	BT 2.1
AS5625G-P824G50Mn	N500GB5.4KS	NSM8XS9.5	3rd WiFi 2x2 BGN	BT 2.1
AS5625G-N533G32Mn	N320GB5.4KS	NSM8XS9.5	3rd WiFi 2x2 BGN	BT 2.1
AS5625G-N334G32Mn	N320GB5.4KS	NSM8XS9.5	3rd WiFi 2x2 BGN	BT 2.1
AS5625-P324G32Mn	N320GB5.4KS	NSM8XS9.5	3rd WiFi 2x2 BGN	N
AS5625-P323G32Mn	N320GB5.4KS	NSM8XS9.5	3rd WiFi 2x2 BGN	N
AS5625-P522G25Mn	N250GB5.4KS	NSM8XS9.5	3rd WiFi 2x2 BGN	BT 2.1
AS5625-N332G25Mn	N250GB5.4KS	NSM8XS9.5	3rd WiFi 2x2 BGN	BT 2.1
AS5625-N332G50Mn	N500GB5.4KS	NSM8XS9.5	3rd WiFi 2x2 BGN	N

Test Compatible Components

This computer's compatibility is tested and verified by Acer's internal testing department. All of its system functions are tested under Windows® 7 environment.

Refer to the following lists for components, adapter cards, and peripherals which have passed these tests. Regarding configuration, combination and test procedures, please refer to the Compatibility Test Report released by the Acer Mobile System Testing Department.

Part Description	Part #
AMD CPU	
CPU AMD AthlonII N330 2.3G 1M 35W Dual-Core	KC.AN002.330
CPU AMD AthlonII P320 2.1G 1M 25W Dual-Core	KC.AP002.320
CPU AMD PhenomII N830 2.1G 35W 1.5M L2, Triple-Core	KC.PN002.830
CPU AMD PhenomII N930 2.0G 2M 35W Quad-Core	KC.PN002.930
CPU AMD PhenomII P820 1.8G 25W 1.5M L2, Triple-Core	KC.PP002.820
CPU AMD PhenomII P920 1.6G 2M 25W Quad-Core	KC.PP002.920
CPU AMD TurionII N530 2.5G 2M 35W Dual-Core	KC.TN002.530
CPU AMD TurionII P520 2.3G 2M 25W Dual-Core	KC.TP002.520
North Bridge Chip Set	
AMD RS880M w/ HDCP EEPROM	KI.22600.050
South Bridge Chip Set	
AMD SB820M	KI.22800.016
LCD 15.6" Panel	
15.6" WSXGA CSV	
LED LCD AUO 15.6"W WXGA Glare B156XW03 V1 LF 220nit 8ms 500:1	LK.15605.004
LED LCD AUO 15.6"W WXGA Glare B156XW04 V0 LF 200nit 8ms 400:1 (Power saving)	LK.15605.015
LED LCD SAMSUNG 15.6"W WXGA Glare LTN156AT11-A01 LF 200nit 16ms 500:1 (Power saving)	LK.15606.008
LED LCD LPL 15.6"W WXGA Glare LP156WH3-TLA2 LF 200nit 8ms 500:1	LK.15608.007
LED LCD LPL 15.6"W WXGA Glare LP156WH3-TLL1 LF 200nit 16ms 500:1 (Power saving)	LK.15608.008
LED LCD CMO 15.6"W WXGA Glare N156B6-L0D LF 200nit 10ms 500:1	LK.1560D.008
System Memory DDRIII	
Memory ELPIDA SO-DIMM DDRIII 1066 1GB EBJ10UE8BDS0-AE-F LF 128*8 0.065um	KN.1GB09.012
Memory SAMSUNG SO-DIMM DDRIII 1066 1GB M471B2873EH1-CF8 LF 64*16 0.055um	KN.1GB0B.028
Memory HYNIX SO-DIMM DDRIII 1066 1GB HMT112S6BFR6C-G7 N0 LF 64*16 0.055um	KN.1GB0G.025
Memory ELPIDA SO-DIMM DDRIII 1333 1GB EBJ10UE8BDS0-DJ-F LF 128*8 0.065um	KN.1GB09.015
Memory ELPIDA SO-DIMM DDRIII 1066 2GB EBJ21UE8BDS0-AE-F LF 128*8 0.065um	KN.2GB09.006

Part Description	Part #
Memory SAMSUNG SO-DIMM DDRIII 1066 2GB M471B5673EH1-CF8 LF 128*8 0.055um	KN.2GB0B.012
Memory HYNIX SO-DIMM DDRIII 1066 2GB HMT125S6BFR8C-G7 N0 LF 128*8 0.055um	KN.2GB0G.014
Memory NANYA SO-DIMM DDRIII 1333 2GB NT2GC64B8HC0NS-CG LF 128*8 0.065um	KN.2GB03.017
Memory ELPIDA SO-DIMM DDRIII 1333 2GB EBJ21UE8BDS0-DJ-F LF 128*8 0.065um	KN.2GB09.007
Memory SAMSUNG SO-DIMM DDRIII 1333 1GB M471B2873FHS-CH9 LF 128*8 46nm	KN.1GB0B.035
Memory ELPIDA SO-DIMM DDRIII 1333 4GB EBJ41UF8BAS0-DJ-F LF 256*8 0.055um	KN.4GB09.001
Memory SAMSUNG SO-DIMM DDRIII 1333 4GB M471B5273CH0-CH9 LF 256*8 46nm	KN.4GB0B.010
Memory HYNIX SO-DIMM DDRIII 1333 4GB HMT351S6AFR8C-H9 LF 256*8 0.055um	KN.4GB0G.003
Memory KINGSTON SO-DIMM DDRIII 1333 1GB ACR128X16D3S1333C9 LF 128*8 0.065um	KN.1GB07.004
Memory HYNIX SO-DIMM DDRIII 1333 1GB HMT112S6TFR8C-H9 LF 128*8 0.055um	KN.1GB0G.026
Memory KINGSTON SO-DIMM DDRIII 1333 2GB ACR256X64D3S1333C9 LF 128*8 0.065um	KN.2GB07.004
Memory SAMSUNG SO-DIMM DDRIII 1333 2GB M471B5673FH0-CH9 LF 128*8 46nm	KN.2GB0B.023
Memory HYNIX SO-DIMM DDRIII 1333 2GB HMT125S6TFR8C-H9 LF 128*8 0.055um	KN.2GB0G.016
Memory NONE SO-DIMM DDRIII 1066 4GB dummy P/N LF	KN.4GB00.001
Hard Drive 9.5mm only - SATA 5400rpm	
HDD WD 2.5" 5400rpm 160GB WD1600BEVT-22A23T0 , WD, ML320S SATA 8MB LF F/W:01.01A01	KH.16008.027
HDD SEAGATE 2.5" 5400rpm 160GB ST9160314AS Wyatt SATA LF F/W:0001SDM1	KH.16001.042
HDD TOSHIBA 2.5" 5400rpm 160GB MK1665GSX, Capricorn BS, 320G/P SATA 8MB LF F/W:GJ001J	KH.16004.008
HDD HGST 2.5" 5400rpm 160GB HTS545016B9A300 Panther B SATA LF F/W:C60F Disk imbalance criteria = 0.014g-cm	KH.16007.026
HDD SEAGATE 2.5" 5400rpm 250GB ST9250315AS Wyatt SATA LF F/W:0001SDM1	KH.25001.016
HDD TOSHIBA 2.5" 5400rpm 250GB MK2565GSX, Capricorn BS, 320G/P SATA 8MB LF F/W:GJ001J	KH.25004.005
HDD HGST 2.5" 5400rpm 250GB HTS545025B9A300 Panther B SATA LF F/W:C60F Disk imbalance criteria = 0.014g-cm	KH.25007.016
HDD WD 2.5" 5400rpm 250GB WD2500BEVT-22A23T0, WD, ML320S SATA 8MB LF F/W:01.01A01.	KH.25008.025
HDD SEAGATE 2.5" 5400rpm 320GB ST9320325AS Wyatt SATA LF F/W:0001SDM1	KH.32001.017
HDD TOSHIBA 2.5" 5400rpm 320GB Capricorn BS ,MK3265GSX SATA 8MB LF F/W:GJ001J	KH.32004.004
HDD HGST 2.5" 5400rpm 320GB HTS545032B9A300 Panther B SATA LF F/W:C60F Disk imbalance criteria = 0.014g-cm	KH.32007.008

Part Description	Part #
HDD WD 2.5" 5400rpm 320GB WD3200BEVT-22A23T0,ML320S,WD SATA 8MB LF F/W:01.01A01	KH.32008.019
HDD SEAGATE 2.5" 5400rpm 500GB ST9500325AS Wyatt SATA LF F/W:0001SDM1	KH.50001.011
HDD TOSHIBA 2.5" 5400rpm 500GB MK5065GSX,Capricorn BS, 320G/P SATA 8MB LF F/W:GJ001J	KH.50004.002
HDD HGST 2.5" 5400rpm 500GB HTS545050B9A300 Panther B SATA LF F/W:C60F Disk imbalance criteria = 0.014g-cm	KH.50007.010
HDD WD 2.5" 5400rpm 500GB WD5000BEVT-22A0RT0, ML320M,WD SATA 8MB LF F/W:01.01A01	KH.50008.017
HDD TOSHIBA 2.5" 5400rpm 640GB MK6465GSX,Capricorn BS,320G/P SATA 8MB LF F/W:GJ001J	KH.64004.001
HDD WD 2.5" 5400rpm 640GB WD6400BEVT-22A0RT0, ML320 SATA 8MB LF F/W:01.01A01	KH.64008.004
Super-Multi (5.25"/ 9.5mm-H) SATA	
ODD TOSHIBA Super-Multi DRIVE 9.5mm Tray DL 8X TS-U633F LF W/O bezel SATA (HF + Windows 7)	KU.00801.034
ODD PANASONIC Super-Multi DRIVE 9.5mm Tray DL 8X UJ892 LF W/O bezel SATA GBAS2.0, (HF + Windows7)	KU.00807.068
ODD HLDS Super-Multi DRIVE 9.5mm Tray DL 8X GU10N LF W/O bezel SATA (HF + Windows 7)	KU.0080D.049
BD COMBO (5.25"/ 9.5mm-H) SATA	
Battery 6-cell	
Battery PANASONIC AS10B Li-Ion 3S2P PANASONIC 6 cell 6000mAh Main COMMON ID:AS10B56 AS10B5E	BT.00605.063
Battery SAMSUNG AS10B Li-Ion 3S2P SAMSUNG 6 cell 6000mAh Main COMMON ID:AS10B6E	BT.00606.009
Battery SIMPLO AS10B Li-Ion 3S2P SAMSUNG 6 cell 6000mAh Main COMMON ID:AS10B7E	BT.00607.128
Battery SANYO AS10B Li-Ion 3S2P SANYO 6 cell 6000mAh Main COMMON ID: AS10B3E	BT.00603.116
Battery SIMPLO AS10E Li-Ion 3S3P SAMSUNG 9 cell 9000mAh Main COMMON ID:AS10E7E	BT.00907.013
AC Adapter 65W/90W adapter	
Adapter DELTA 65W 19V 1.7x5.5x11 Yellow ADP-65JH DB A, LV5 LED LF	AP.06501.026
Adapter DELTA 65W 19V 1.7x5.5x11 Yellow ADP-65VH BA, LV5, Low profile LED LF	AP.06501.033
Adapter LITE-ON 65W 19V 1.7x5.5x11 Yellow PA-1650-22AC LV5 LED LF	AP.06503.024
Adapter LITE-ON 65W 19V 1.7x5.5x11 Yellow PA-1650-69AW, LV5, Low profile LED LF	AP.06503.029
Adapter HIPRO 65W 19V 1.7x5.5x11 Yellow HP-A0652R3B 1LF, LV5 LED LF	AP.0650A.012
Adapter Chicony Power 65W 19V 1.7x5.5x11 Yellow CPA09-A065N1, LV5, low profile LED LF	AP.0650A.017
Adapter DELTA 90W 19V 1.7x5.5x11 Blue ADP-90CD DB A, LV5 LED LF	AP.09001.027
Adapter LITE-ON 90W 19V 1.7x5.5x11 Blue PA-1900-34AR, LV5 LED LF	AP.09003.021
Adapter HIPRO 90W 19V 1.7x5.5x11 Blue HP-A0904A3 B1LF, LV5 LED LF	AP.0900A.005
power code(3PIN)	
PWR CORD (5-KAF1812) US,3P 1.85MM/BLK	

Part Description	Part #
VRAM side port	
VRAM SAMSUNG Graphic DDRIII 800 1Gb K4W1G1646E-HC12 LF	VR.1GB0B.006
VRAM HYNIX Graphic DDRIII 800 1Gb H5TQ1G63BFR-12C LF	VR.1GB0G.004
VRAM ATI Graphic DDRIII 800 1Gb 23EY2387MA12-SZ LF+HF	VR.1GB0T.002
VRAM	
VRAM SAMSUNG Graphic DDRIII 800 1Gb K4W1G1646E-HC12 LF	VR.1GB0B.006
VRAM HYNIX Graphic DDRIII 800 1Gb H5TQ1G63BFR-12C LF	VR.1GB0G.004
VRAM ATI Graphic DDRIII 800 1Gb 23EY2387MA12-SZ LF+HF	VR.1GB0T.002
VGA chip	
AMD MADISON_PRO 40nm 29mm*29mm M2 package	KI.23200.169
AMD PARK_XT 40nm 29mm*29mm M2 package	KI.23200.162
Wireless Lan Mini Card	
Foxconn Wireless LAN Atheros HB93 2x2 BGN (HM)	NI.23600.062
Foxconn Wireless LAN Broadcomm 43225 2x2 BGN (HM) T77H103.00	NI.23600.066
Foxconn Wireless LAN Atheros HB97 2x2 BGN (HM)	NI.23600.072
Foxconn Wirelss LAN Atheros HB95BG (HM) T77H121.10	NI.23600.077
Lan	
Atheros AR8151L	NI.22400.048
Keyboard	
Keyboard-AC7T 358.27x113.44x4.9mm (Max, texture)	
Keyboard ACER AC7T JV40 Internal 14 Standard Black Texture (Darfon)-UI	
Keyboard ACER AC7T JV40 Internal 14 Standard Black Texture (Darfon)-UK	
Keyboard ACER AC7T JV40 Internal 14 Standard Black Texture (Chicony)-UI	
Keyboard ACER AC7T JV40 Internal 14 Standard Black Texture (Chicony)-UK	
Bluetooth	
Foxconn Bluetooth BRM 2046 BT2.1 (T60H928.33) f/w:861	BH.21100.004
Foxconn Bluetooth ATH AR3011	BH.21100.005
Foxconn Bluetooth BRM 2070 (T77H114.01)	BH.21100.007
Foxconn Bluetooth BRM 2046 BT3.0 (T60H928.33) f/w:861	BH.21100.008
Foxconn Bluetooth ATH AR3011 (BT3.0)	BH.21100.009
Foxconn Bluetooth BRM 2070 (T77H114.01) BT 3.0	BH.21100.010
Antenna	
PIFA	LZ.23500.006
Audio codec	
Realtek ALC271X	LZ.21000.069
Digital MIC	
Camera	
Chicony 1.3M CH9665SN (CNF9157)	AM.21400.067
Suyin 1.3M SY9665SN	AM.21400.068
Liteon 1.3M LT9665AL (09P2SF119)	AM.21400.069
Liteon 1.3M LT6AASP(09P2BF127)	AM.21400.070

Part Description	Part #
Modem	
External USB Lite+LSI modem	LC.MOD00.001

Online Support Information

This section describes online technical support services available to help you repair your Acer Systems.

If you are a distributor, dealer, ASP or TPM, please refer your technical queries to your local Acer branch office. Acer Branch Offices and Regional Business Units may access our website. However some information sources will require a user i.d. and password. These can be obtained directly from Acer CSD Taiwan.

Acer's Website offers you convenient and valuable support resources whenever you need them.

In the Technical Information section you can download information on all of Acer's Notebook, Desktop and Server models including:

- Service guides for all models
- User's manuals
- BIOS updates
- Software utilities
- Spare parts lists
- TABs (Technical Announcement Bulletin)

For these purposes, we have included an Acrobat File to facilitate the problem-free downloading of our technical material.

Also contained on this website are:

- Detailed information on Acer's International Traveler's Warranty (ITW)
- Returned material authorization procedures
- An overview of all the support services we offer, accompanied by a list of telephone, fax and email contacts for all your technical queries.

We are always looking for ways to optimize and improve our services, so if you have any suggestions or comments, please do not hesitate to communicate these to us.

A

Antennas
 Removing 102, 107

B

Battery Pack
 Removing 54

BIOS
 ROM type 28
 vendor 28

BIOS Utility 33–42
 Advanced 37
 Boot 40
 Exit 41
 Navigating 33
 Power 40
 Save and Exit 41
 Security 37
 System Security 41

brightness
 hotkeys 13

C

Camera Board
 Removing 98, 113

caps lock
 on indicator 9

Common Problems 150

CPU
 Replacing 119

CRT Cable
 Removing 88

D

DIMM Module
 Removing 60

Display 5

display
 hotkeys 13

E

Euro Key 14

External Module Disassembly
 Flowchart 52

F

Features 1

FLASH Utility 42

Flash Utility 42

FRU (Field Replaceable Unit) List 169

H

Hard Disk Drive Module
 Removing 58

Hibernation mode
 hotkey 13

Hot Keys 11

I

Indicators 9

Intermittent Problems 160

Internal Microphone Failure 157

Internal Speaker Failure 156

J

Jumper and Connector Locations 165

K

Keyboard
 Removing 69

Keyboard Failure 154

L

LCD Bezel
 Removing 96, 114

LCD Failure 153

LCD Module
 Removing 127

LCD Module Disassembly
 Flowchart 95

LCD Panel
 Removing 99, 111

M

Main Unit Disassembly
 Flowchart 66

Mainboard
 Removing 88
media access
 on indicator 9
Memory Check 150
Microphone
 Removing 99, 111
Model Definition 181

N

No Display Issue 151
num lock
 on indicator 9

O

ODD Failure 159
Online Support Information 219

P

Panel 6
PC Card 9
Power On Failure 150

S

Speaker Module
 Removing 86
speakers
 hotkey 13
System
 Block Diagram 5

T

Test Compatible Components 213
Thermal Module
 Removing 90
Touch Pad Failure 155
Troubleshooting
 Built-in KB Failure 154
 Internal Microphone 157
 Internal Speakers 156
 LCD Failure 153
 No Display 151
 ODD 159
 Other Failures 159
 Power On 150
 Touch Pad 155

USB 159

U

Undetermined Problems 160
Upper Cover
 Removing 71
USB Failure (Rightside) 159
utility
 BIOS 33–42

V

volume
 hotkeys 13

W

Windows 2000 Environment Test 213
WLAN Board
 Removing 61

